



# Compressed Air Contamination

A White Paper By Mark White - Compressed Air  
Treatment Applications Manager



ENGINEERING YOUR SUCCESS.  
[www.parker.com/gsf](http://www.parker.com/gsf)

# Introduction

For over 100 years, compressed air has been recognised as a safe and reliable power source that is widely used throughout industry. Known as the 4th utility, approximately 90% of all manufacturing companies use compressed air in some aspect of their operations. Unlike gas, water & electricity which is supplied to site by a utility supplier and to strict tolerances and quality specifications, compressed air is generated on-site by the user. The quality of the compressed air and the cost of producing this powerful utility is therefore the responsibility of the user.

## The Problem with Compressed Air.

Compressed air systems inherently suffer from performance and reliability issues and almost all of the problems associated with the compressed air system and many manufacturing related quality issues can be directly attributed to contamination found in the compressed air.

## Compressed Air Contamination and its Sources

Unknown to many compressed air users, the compressed air system contains a large array of both visible and invisible contamination which actually originate from four different sources.

## The 4 Sources of Compressed Air Contamination

1. The Ambient Air
2. The Air Compressor
3. The Air Receiver
4. The Distribution Piping

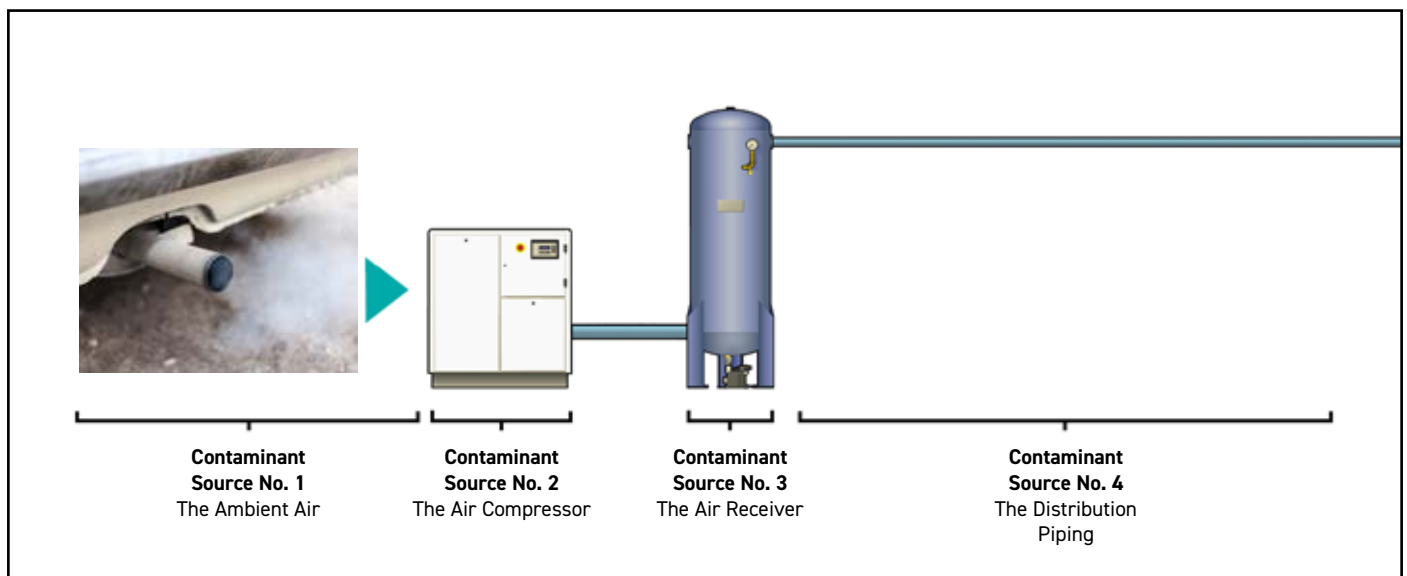

# Contamination Source Number 1 - The Ambient Air

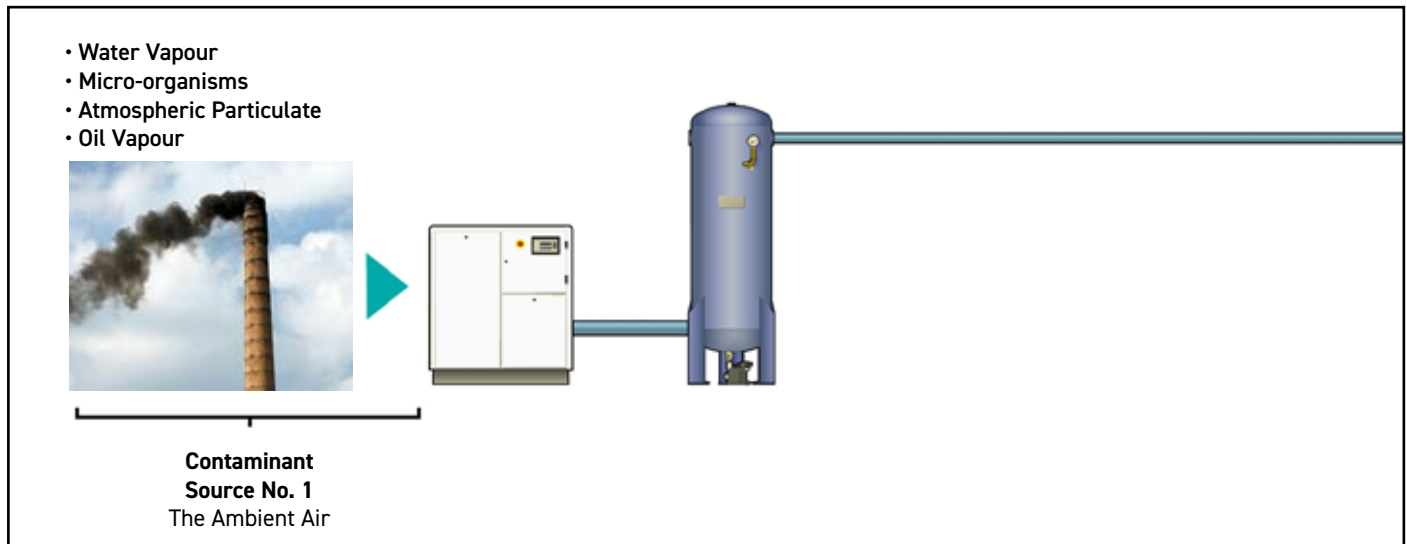

The primary source of contamination found in a compressed air system is the ambient air surrounding the compressor. In simple terms, the air compressor is just a large air mover. When operating, it pulls in large volumes of air around it, squeezes it, and pushes it out down a pipe. However, when doing so it also acts like a large vacuum cleaner, pulling in invisible contaminants. So, when the ambient air is compressed, the compressor is also concentrating the contamination at the same time.

## The Main Contaminants Found in Ambient Air (Source 1)

- Water Vapour
- Micro-organisms
- Atmospheric Particulate
- Oil Vapour\*

*\*For a more in depth review of ambient air oil vapour levels, refer to "White Paper - Oil Vapour in Ambient Air"*

## Additional Contaminants Found in Ambient Air (Source 1)

The 4 contaminants highlighted above are the main contaminants of interest for general applications, however there are also other contaminants entering the compressor intake, which depending upon how the compressed air is used, may also require focus. The additional contaminants include:

- Sulphur Dioxide (SO<sub>2</sub>)
- Nitrogen Oxides (NO + NO<sub>2</sub>)
- Carbon Monoxide (CO)
- Carbon Dioxide (CO<sub>2</sub>)

# Contamination Source Number 2 - The Air Compressor

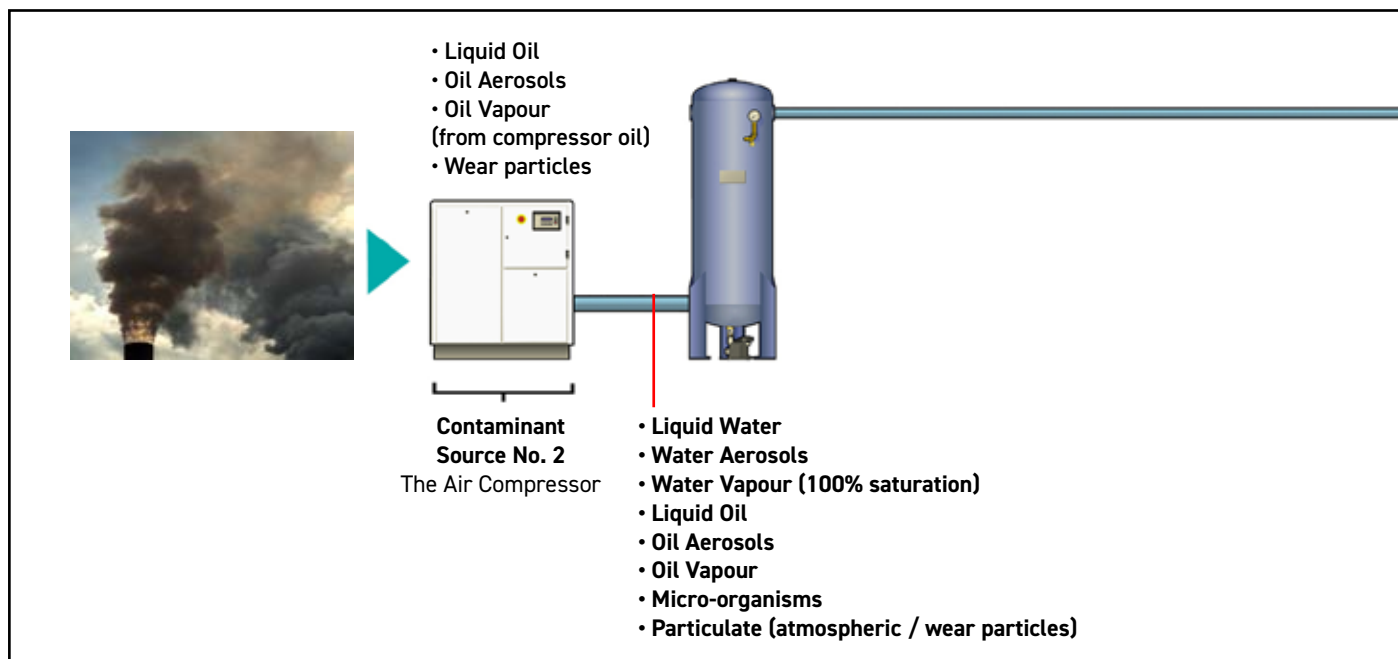

During the compression and cooling process, the air compressor also changes the phase of the invisible gaseous contaminants it has ingested, and with a change of phase, many invisible contaminants now become visible. In addition to changing the phase of the ambient contaminants, the air compressor is also responsible for adding contamination of its own, making it contamination source number 2.

## Contaminants Added by the Air Compressor (Source 2)

- Liquid Oil
- Oil Aerosols
- Oil Vapour (from compressor oil)
- Wear particles

## Gaseous Ambient Contaminants Converted by the Air Compressor

- Oil Vapour
- Water Vapour

## Both of these Gaseous Contaminants Cool and Condense to Form:

- Liquid oil
- Oil aerosols
- Liquid Water
- Water Aerosols

So, by the time the air exits the compressor after-cooler and no matter what type of compressor is used (oil lubricated / oil free), the following contaminants will be present in the compressed air:

- Liquid Water
- Water Aerosols
- Water Vapour (100% saturation)
- Liquid Oil
- Oil Aerosols
- Oil Vapour
- Micro-organisms
- Particulate (atmospheric / compressor wear particles)

# Contamination Source Numbers 3 & 4

## The Air Receiver & The Distribution Piping

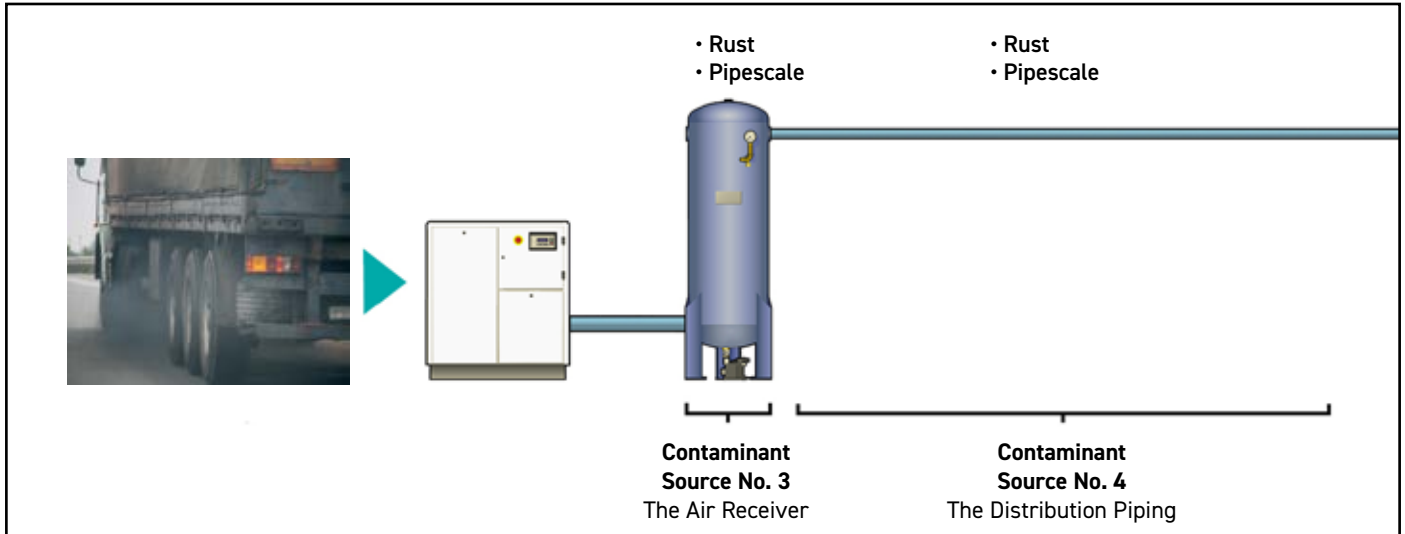

### Contamination Source Number 3 - The Air Receiver

Contamination source number 3 is the air receiver. Installed in a compressed air system to store compressed air and increase the efficiency and reliability of the compressor, the air receiver also stores large quantities of contamination. These contaminants also lead to chemical reactions and oxidation which in turn, lead to additional contaminants being added to the compressed air.

#### Contaminants Added by the Air Receiver (Source 3)

- Rust
- Pipescale

The wet air receiver (a receiver installed before a dryer) can reduce the compressed air temperature by up to 5°C. This cooling will cause further condensation of oil and water vapours into liquid oil and water. A wet air receiver is often chosen for this purpose as it can provide additional cooling of the compressed air at times where the ambient and compressed air temperatures are higher than expected. Unfortunately, it also provides the ideal environment for the rapid growth of micro-organisms, especially in the compressor condensate.

### Contamination Source Number 4 - Distribution Piping

In a typical compressed air system, the final source of contamination is the distribution piping which takes the compressed air from the compressor and distributes it around the manufacturing facility. Just like the air receiver, the distribution piping not only stores contamination, it also adds to the contaminant problem, through chemical reactions and oxidation, again adding rust and pipescale to the compressed air and providing an environment that promotes the growth of micro-organisms.

#### Contaminants Added by the Distribution Piping (Source 4)

- Rust
- Pipescale

As with the air receiver, the distribution piping will also cool compressed air causing further condensation of oil and water vapours into liquid oil and water which in turn form aerosols of oil and water as the air pulls the liquid along the piping.

# Contaminant Summary

In order to protect equipment, products and processes that use or have direct or indirect contact with compressed air, there are a minimum of TEN contaminants originating from FOUR different sources that must be treated.

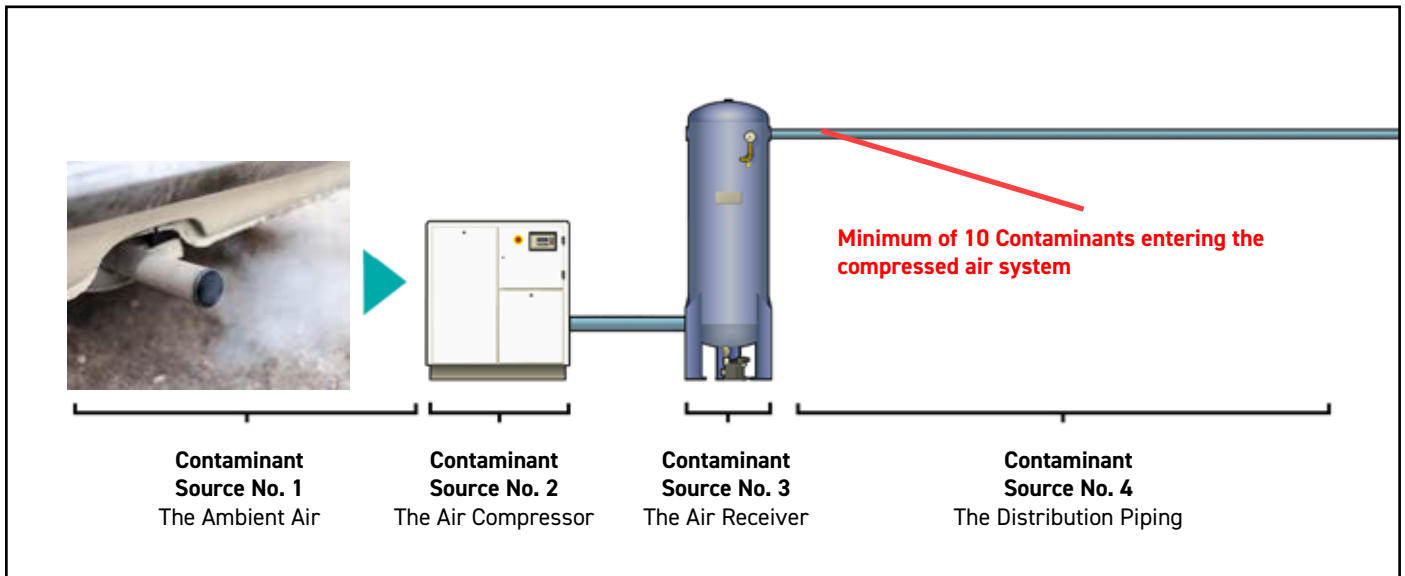

## Contamination entering the compressed air system

Water	Oil	Particulates	Organic
Water Vapour	Oil Vapour	Atmospheric Particles	Micro-organisms
Liquid Water	Liquid Oil	Compressor Wear Particles	
Water Aerosols	Oil Aerosols	Rust / Pipescale	

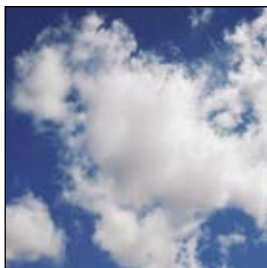

Water Vapour

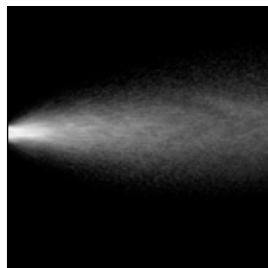

Water Aerosol  
Oil Aerosol



Liquid Water



Micro-organisms



Oil Vapour



Liquid Oil



Particulates



Rust & Pipescale

# Breathable Compressed Air / Medical Air

If the compressed air is used as breathing air, medical air or for other critical applications, then additional, potentially life threatening contaminants in the ambient air must also be considered.

## Contaminants of concern for Breathing Air / Medical Air Applications

- Sulphur Dioxide (SO<sub>2</sub>)
- Nitrogen Oxides (NO + NO<sub>2</sub>)
- Carbon Monoxide (CO)
- Carbon Dioxide (CO<sub>2</sub>)

Therefore, for Breathable Compressed Air / Medical Air / Critical applications, there are a minimum of 15 contaminants that must be treated.

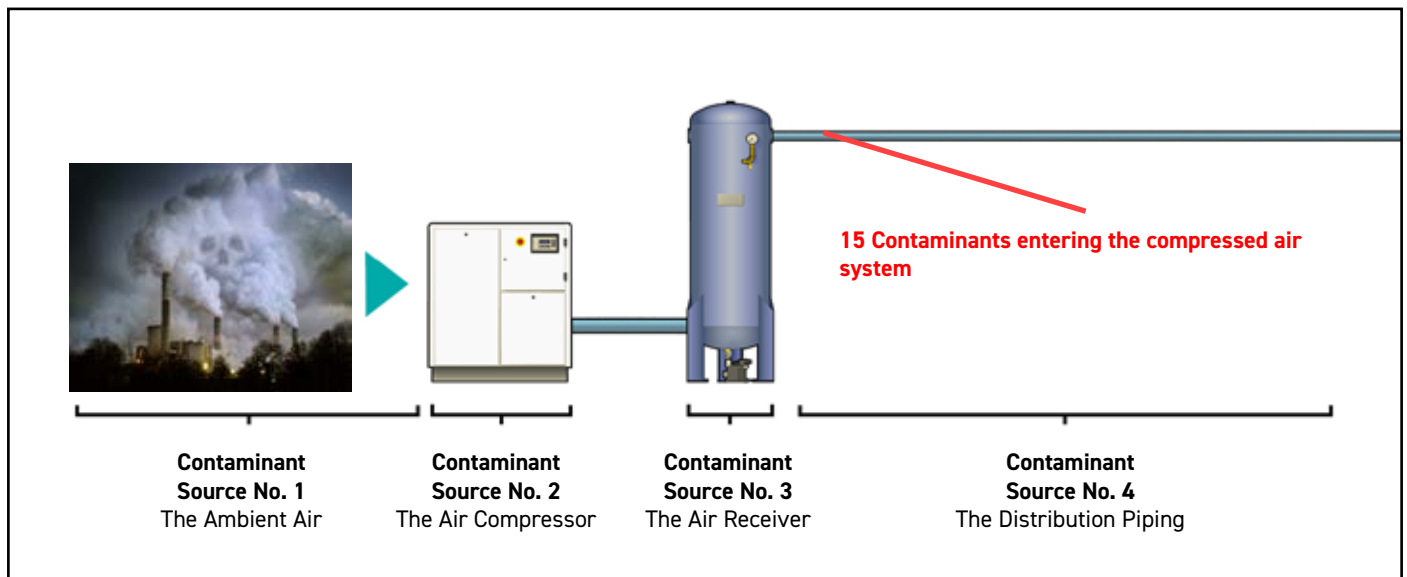

## Contamination Entering the Compressed Air System (Breathing Air)

Water	Oil	Particulates	Organic	Gaseous
Water Vapour	Oil Vapour	Atmospheric Particulates	Micro-organisms	Sulphur Dioxide (SO <sub>2</sub> )
Liquid Water	Liquid Oil	Compressor Wear Particles		Nitrogen Oxides (NO + NO <sub>2</sub> )
Water Aerosols	Oil Aerosols	Rust / Pipescale		Carbon Monoxide (CO)
				Carbon Dioxide (CO <sub>2</sub> )

### Atmospheric Pollutants

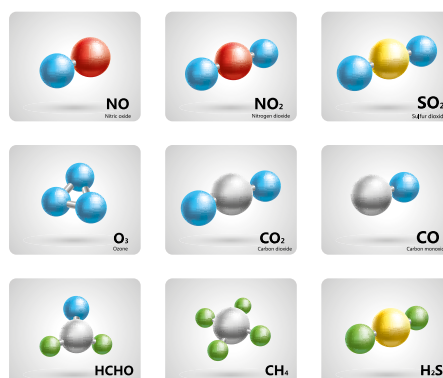

# Compressed Air Contaminants In Detail

## Oil Vapour, Oil Aerosols & Liquid Oil

Oil contamination in compressed air is one of the most contentious subjects in the industry. This is due mainly to the fact that no matter what technology is used to compress air; manufacturers will probably offer that compressor type both as an oil lubricated and oil-free variant.

So, when it comes to providing clean compressed air at the point of use, we must understand where the oil comes from and in what form it is present.

As previously seen, oil will be present in a compressed air system as a vapour, as an aerosol and as a liquid, and will originate from two sources.

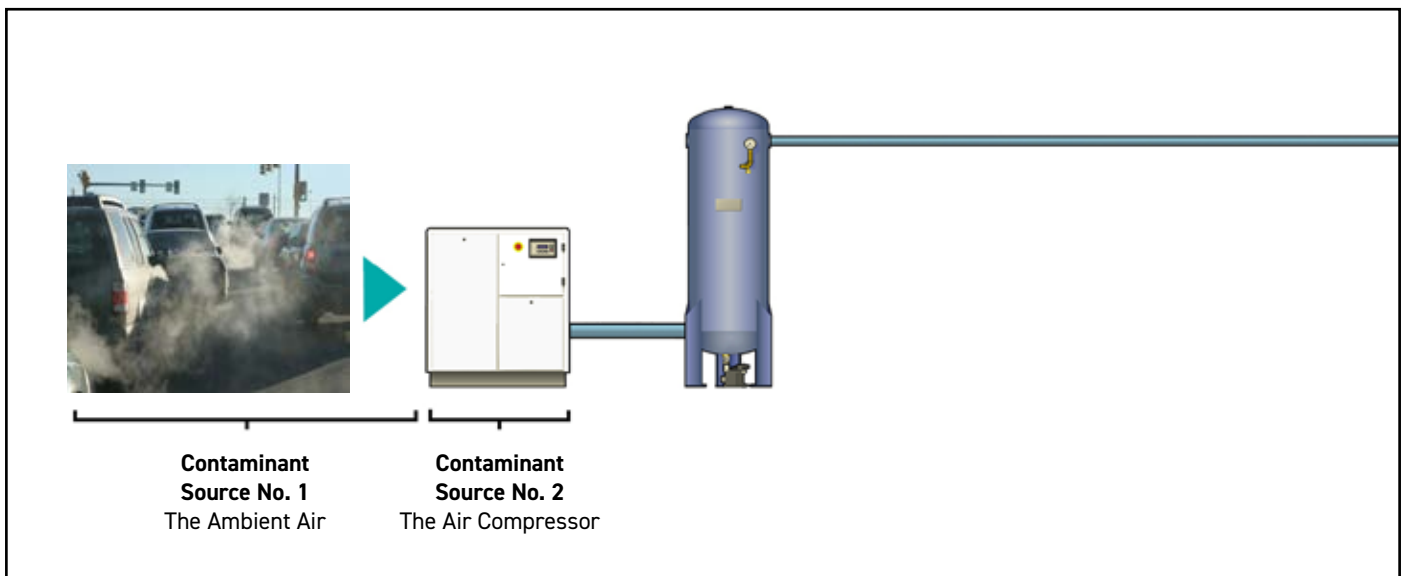
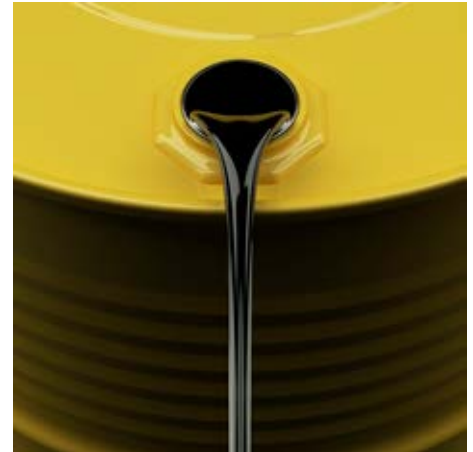

### What do we mean by “Oil Vapour”?

When we (the compressed air industry) talk about oil vapour in ambient air, we are actually referring to a combination of hydrocarbons and VOC (Volatile Organic Compounds).

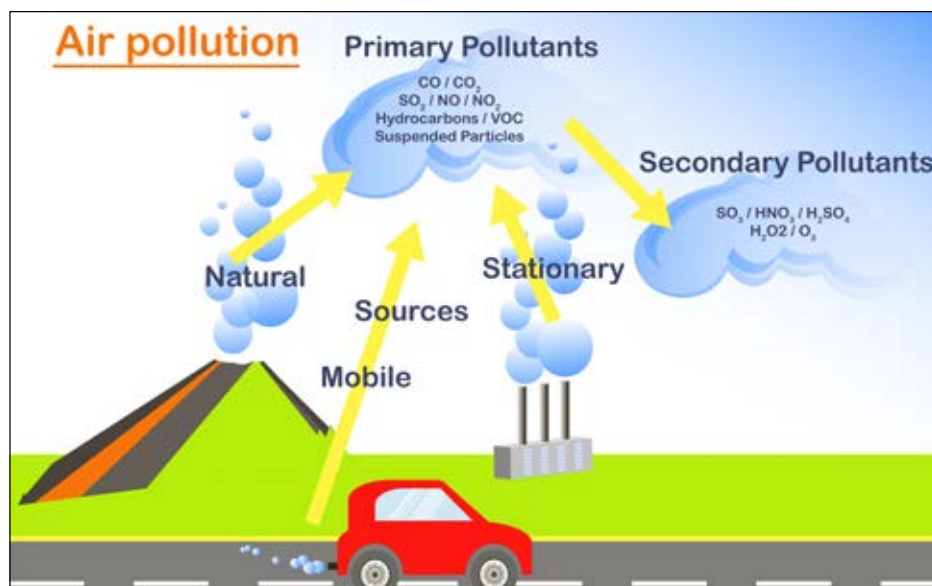



# Oil Contamination Source 1 - The Ambient Air

How do we know how much “Oil Vapour” is in the ambient air? As previously stated, the oil as we know it is a mixture of many different compounds. There is no single “oil” in air test available, therefore we must test the ambient air for the different compounds and combine the test results.

Global and European targets to improve air quality has led to many air quality sample stations being set up to test for the compounds which are more harmful to human health (typically, NOX, SOX, CO, CO<sub>2</sub> & Ozone).



However, a number of these facilities also test for additional compounds, especially the VOC and we can use this data to verify the presence of “Oil Vapour” in the ambient air.

**Ambient air typically contains between 0.05mg/m<sup>3</sup> and 0.5mg/m<sup>3</sup> of oil vapour, however this can be higher in dense, urban or industrial environments or next to car parks and busy roadways\*.**

\*For a more in depth review of ambient air oil vapour levels, refer to “White Paper - Oil Vapour in Ambient Air”.

## So, why should we be concerned about ambient oil vapour?

Many companies, especially those in the food, beverage, pharmaceutical, cosmetics & electronics industries use compressed air as part of their manufacturing process.

Often this compressed air will directly or indirectly contact production equipment, instrumentation, products & packaging materials. If this compressed air contains “oil”, the consequences can be high both financially and in terms of brand damage.

For this reason, many companies specify the use of an oil-free compressor, in the mistaken belief that this will deliver “oil-free” compressed air to the critical applications.

We have already shown that ambient air contains oil in the form of hydrocarbon compounds & VOC and once drawn into the compressor intake, these are concentrated.

**As the compressed air exits the compressor and enters the piping system, some of these compounds will cool, condense and form what we know as liquid oil and aerosols of oil, whilst others remain in the compressed air as oil vapour.**



# Contamination Source 2 - The Air Compressor

## Overview of Screw Compressor Operation Oil Injected (Lubricated)

There are number of different terms used to describe a lubricated compressor (Oil Injected / Oil Lubricated / Contact Cooled) however the designs all have one thing in common, they use oil for sealing, cooling and lubrication. In fact, the lubricated compressor accounts for approximately 75% of industrial screw compressors sold globally.

As the rotary screw compressor is the most common, this type has been used to describe the basic operation of an oil injected compressor.

### Basic Operation - Oil Injected Rotary Screw Compressor

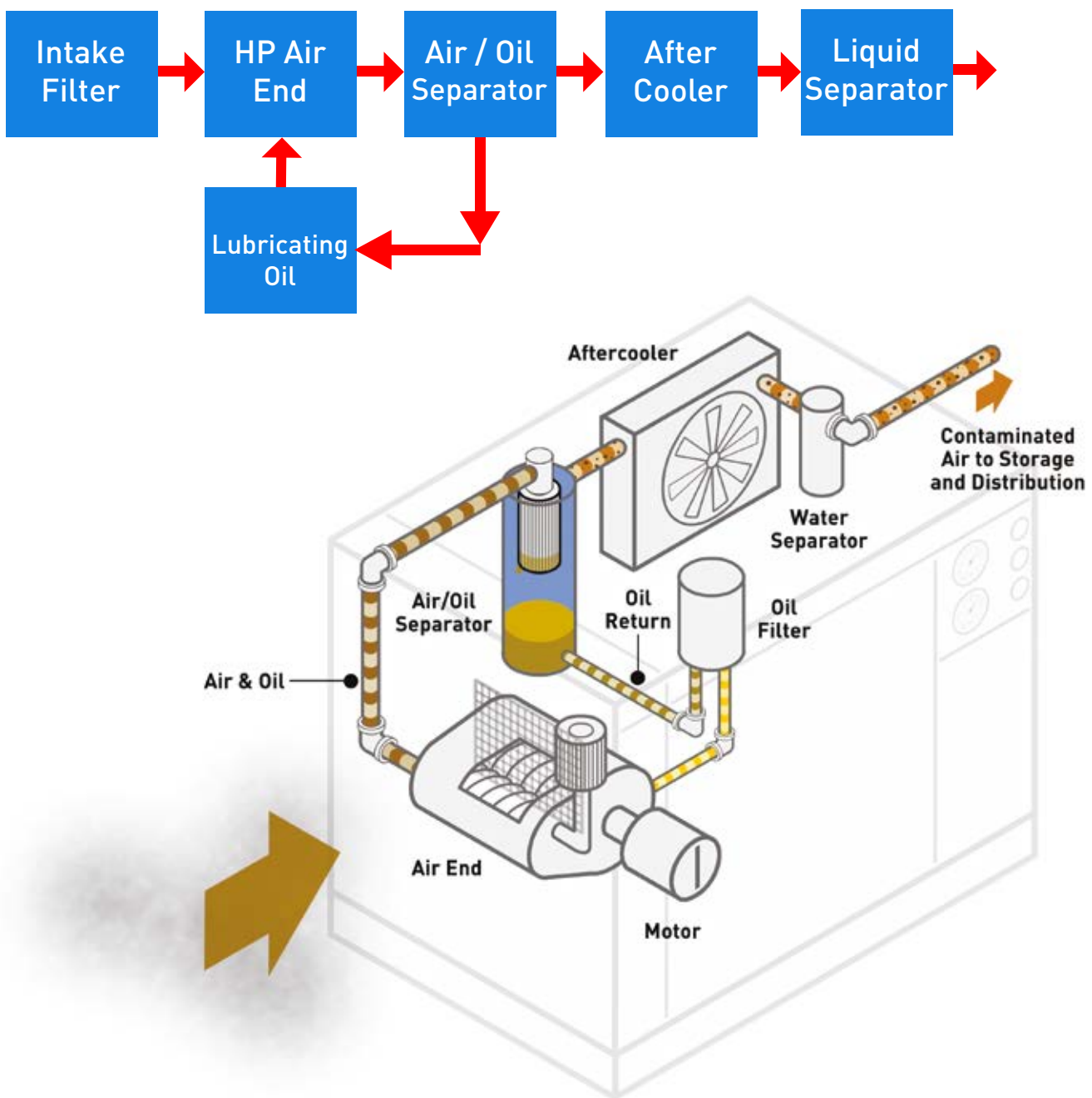

## Drive

A motor, usually electric (sometimes diesel on portable compressors), is used to drive the compression stage.

## Compression

The compression stage is commonly known as the 'air end' and consists of two inter-meshing rotors (helical screw), one male, one female. One rotor is typically driven directly by the motor (its speed governed by gearing) whilst the other is typically freely rotating (pushed by the lubricating oil).

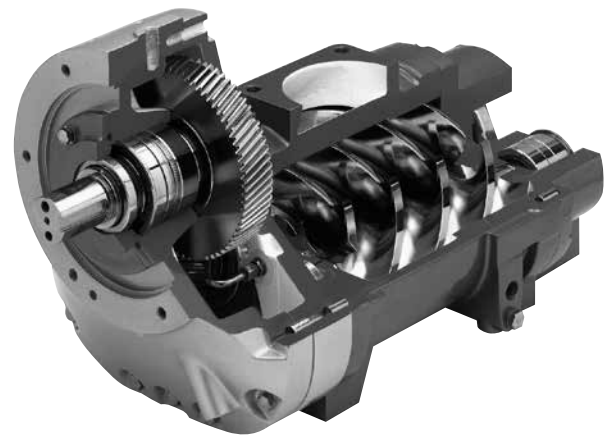

As the screws rotate, ambient air is pulled into the air end, gets trapped in pockets between the two screws and is compressed. As long as the rotors turn, air is drawn in at one end and is discharged at pressure out of the other. A non-return valve prevents air discharging back through the compressor when the drive motor is off.

## Sealing

During operation, oil is injected into the compression stage for sealing. The two rotors in the air end do not actually touch each other due to the oil. The oil provides a very efficient seal which allows compression of the ambient air to take place.



## Cooling (of the compressed air during compression / rotors / air end housing)

When the ambient air is compressed, heat is produced (commonly referred to as the heat of compression). The oil in a lubricated compressor directly cools the compressed air, the rotors and the air end housing and up to 80% of the heat in the compression stage can be removed by the oil. This keeps air end discharge temperatures low, increasing efficiency. Typical air temperatures are between 80°C & 120°C, therefore for most industrial operating pressures, using direct cooling with oil allows compression with a single air end only (single stage).

## Lubrication

As air compressors consist of many moving parts (bearings and gears), the oil is also used for lubrication of these components.

## Oil Reclamation

Following compression, the compressed air is now laden with oil. An air/oil separation filter built into a closed loop lubrication system is used to reclaim the oil from the compressed air before it exits the compressor. The oil will be filtered for particulate contamination and cooled before re-circulation, where it will once again be used for sealing, cooling and lubrication.



## Oil Carryover (Aerosol)

The filter used in the air / oil separator is dealing with high levels of liquid oil and oil aerosols. Due to the way mechanical filters operate, the air / oil separator is unable to reclaim 100% of the oil, resulting in a small amount of oil aerosol remaining in the compressed air leaving the compressor. This is known as 'oil carryover'. Literature for lubricated compressors will usually provide a figure for oil carryover. Typical oil carryover values for common industrial compressor types are shown below:

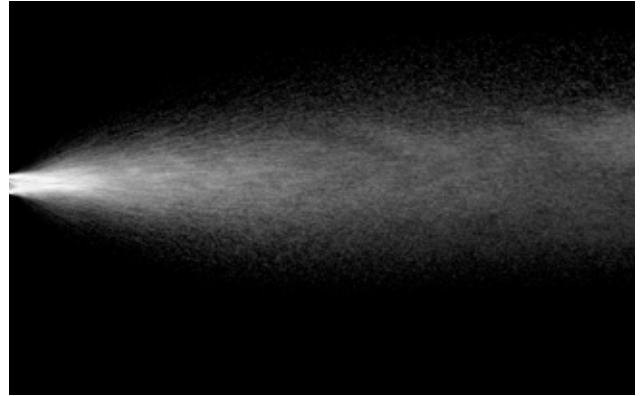

Compressor Type	Typical Oil Carryover Values
Oil Flooded Rotary Screw Compressors	<5 mg/m <sup>3</sup>
Rotary Vane Compressors	<5 mg/m <sup>3</sup>
Reciprocating (Piston) Compressors	New: 25 mg/m <sup>3</sup> / Old: 100-200 mg/m <sup>3</sup>

### Important Note:

Oil Vapour (hydrocarbons and VOC) from the ambient air can be captured by the lubricating oil during compression.

## Oil Carryover (Vapour)

As the lubricating oil heats up during operation, its evaporation rate increases (this will vary between different lubricants). Oil vapour will therefore be introduced into the compressed air by a lubricated compressor. As the oil is in a vapour phase, it will not be reduced by the air / oil separator.



## Post Compression Cooling (After-cooler)

The air exiting the compression stage of an oil lubricated compressor, although cooled by the lubricating oil, is still too hot for use and will therefore require further cooling. This cooling is carried out by the After-cooler.

Many industrial compressors will incorporate an integrated After-cooler inside the compressor package, whilst some compressor manufacturers may supply these as additional, external items.

After-coolers can be split into air cooled and water-cooled variants, with air cooled being the most common.

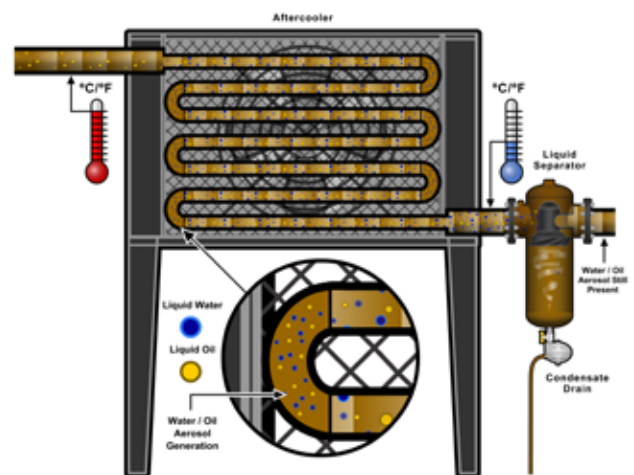

## Air Cooled After-cooler

This is essentially a long length of piping coiled to form a cooling pack. Manufactured from materials with high heat transfer properties, many will incorporate additional “cooling fins” attached to the piping for additional heat transfer. A large cooling fan will blow ambient air over the cooling pack, resulting in heat from the compressed air being transferred to the moving ambient air. A typical air cooled After-cooler will provide discharge air from the compressor approximately 10°C to 15°C above the ambient air temperature (Assuming the compressor room is well ventilated, and the After-cooler is kept clean).



## Water Cooled After-cooler

On a water-cooled After-cooler, the cooling pack is replaced by multiple straight pipes, integrated into a watertight vessel. Chilled water from a separate closed loop cooling system is constantly circulated around the pipes flowing the compressed air.



Heat from the compressed air transfers into the cooling water (heating it up). Warm water is then returned to the chiller to be cooled once again. Water cooled After-coolers are often used when ambient air temperatures are too high for an air-cooled After-cooler to be efficient.

## Liquid & Aerosol Introduction

As the After-cooler cools the compressed air, it reduces the air's ability to hold water and oil vapours. Cooling condenses the vapours into liquid water and liquid oil which is carried along in the air at high velocity. Rough internal surfaces of the piping, bends, elbows, fittings, etc. all disrupt the flow of condensed liquids. This disruption causes the condensed liquids to ‘shear’ or atomise, producing fine droplets or aerosols of water and oil.

## Liquid Reduction

Many air compressors are fitted with an integrated water separator at the outlet of the After-cooler to reduce liquids. Some compressor designs rely on an external water separator or use a wet air receiver for liquid reduction.



### Important Notes:

Water separators reduce liquids only, they are not effective for aerosol or vapour reduction and they will not remove 100% of the liquid present.

# Contamination Source 2 - The Air Compressor

## Overview of Screw Compressor Operation Oil Free

The obvious thought is that the term 'Oil free compressor' describes a compressor containing no oil. Unfortunately, that is not the case for most oil free compressors. An oil free compressor is the term used to describe a compressor that does not use oil in its compression stage.

### Basic Operation - Oil Free Rotary Screw Compressor

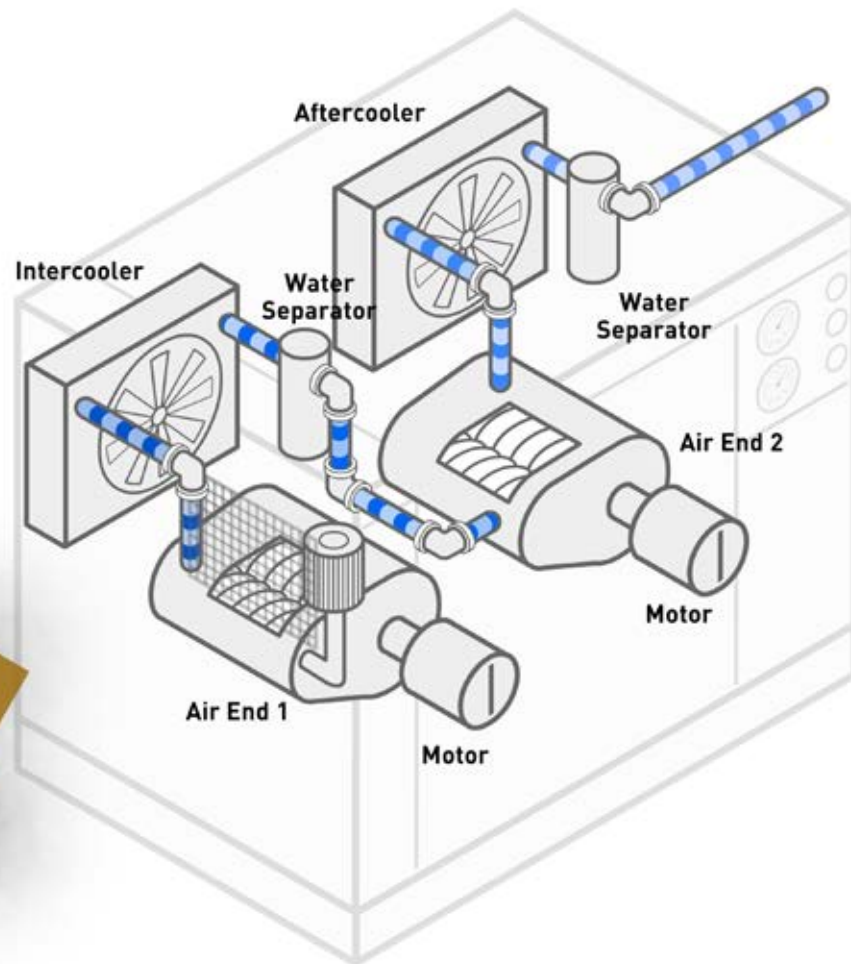

### Drive

Oil free rotary screw compressors are typically multi stage, driven by a single drive motor. This motor will drive a gear which in turn distributes the power to each air end. Some oil free screw compressors are now available where each compression stage driven by an individual motor

## Compression

Unlike the oil injected screw compressor which uses oil to seal the gaps between the rotors and provide compression, oil free variants achieve compression in an alternative way.

Rotor elements are manufactured in pairs with extremely tight tolerances to decrease the gap between them. During operation, rotors are spun at much higher speeds than an equivalent oil injected compressor. Specialist coatings are often applied to the rotors to give some of the protection from water and heat usually provided by oil.

The rotors operate extremely close to each other, however as there is no oil in the compression stage to prevent the rotors from touching, the distance between each rotor is maintained by additional gearing.

## Cooling

As there is no oil in the compression chamber to provide direct cooling, indirect cooling is used. The air end housings of oil free compression stages typically contain galleries in which cooling water (on water cooled machines) or oil (on air cooled machines) can be circulated. This process is not as efficient as direct cooling as it only cools the casing and not the compressed air or the rotors.

Due to the lack of direct cooling in an oil free compressor, the compressed air and rotors reach much higher temperatures. Oil-free compressors therefore obtain their final discharge pressure in stages (as opposed to oil injected machines which typically use only 1 stage). Between stages they will cool the compressed air with an inter-cooler. This keeps typical air end temperatures between 180°C & 200°C.

*For example, on a typical oil free rotary screw compressor with 2 compression stages, an inter-cooler and after-cooler. Stage 1 will typically compress the air up to a pressure around 3.5 bar g, stage 2 will then compress the air to the discharge pressure of 7 bar g.*

## Lubrication

On an oil free screw compressor, it is not only important that the individual rotors in each air end are synchronised with gears, with only one drive motor, additional gearing is also required to drive each of the air ends. All of the gearing and bearings require lubrication.

So although the name implies that an oil free compressor is “oil less”, for most oil free compressors sold, this is not the case. Oil is not used in the compression stages; however, oil is still required for lubrication and cooling of other components. This oil is pumped around the compressor forming a closed loop system which lubricates bearings and gears, is filtered, cooled and recirculated.

## Oil Reclamation (Air / Oil Separator)

As there is no oil used in the compression stage, there is no requirement for an air / oil separator on an oil free compressor.

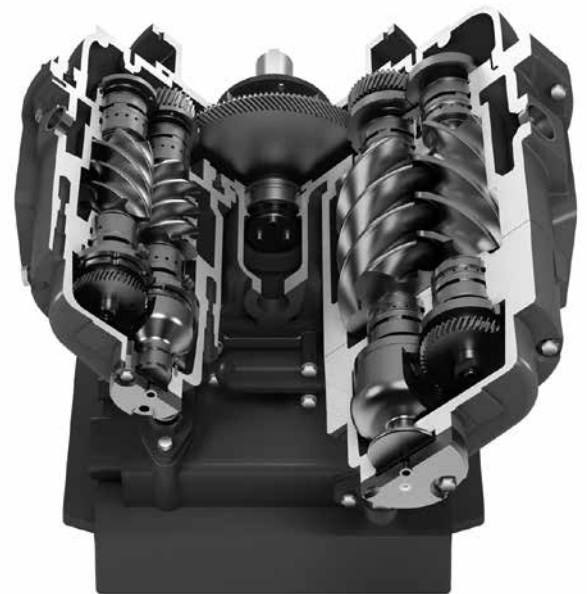

## Oil Carryover (from the ambient air)

It is often thought that an oil free compressor will provide oil free compressed air (due to the fact it does not use oil in the compression of the air). Unfortunately this is not true.

Oil vapours in the ambient air are drawn into the compressor intake, compressed and concentrated. The concentrated vapours then enter the compressed air distribution system where they can cool and condense. This results in the presence of oil contamination (in a liquid, aerosol and vapour phase).

The amount of oil in the compressed air downstream of an oil free compressor is primarily dependent upon the ambient air quality.

The table (right) highlights the increased 'oil vapour' contamination levels that 1 cubic meter of compressed air would contain (at typical industry operating pressures).

Additionally, many compressor intakes are sited in industrial areas and / or next to car parks and roads, where the ambient contamination levels can be significantly higher, leading to higher concentrations once compressed.



Pressure	Industry Values	
	Min	Max
Ambient	0.05	0.50
7 bar g	0.40	4.00
10 bar g	0.55	5.50
13 bar g	0.70	7.00
40 bar g	2.00	20.0

**All Concentration Values in mg/m<sup>3</sup>**

## Oil Carryover (from the compressor)

The oil used in the closed loop system of the oil free compressor to cool and lubricate the bearings and gears heats up and vaporises during operation.

The compressor is fitted with a simple 'breather' filter to prevent over pressurisation of the oil circuit.

This breather filter allows aerosols and vapours to exit the casing and be drawn into the compressor intake, which in turn increases the amount of oil contamination going downstream.

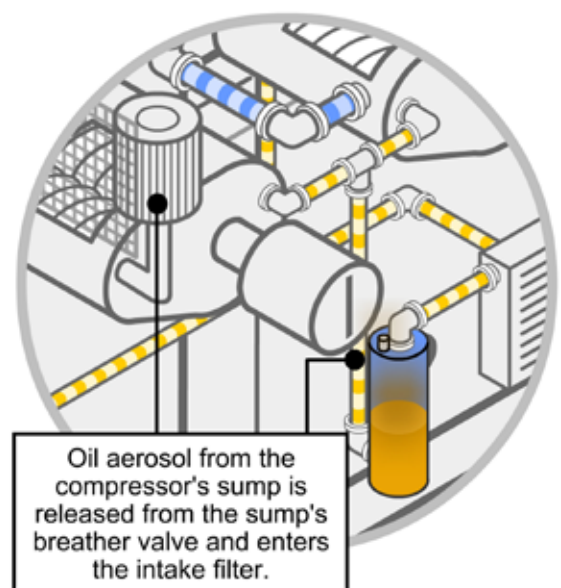



## Inter-cooling / After-cooling

Without the ability to provide direct cooling with oil, oil free machines typically use two compression stages.

Placed in between the two stages is an inter-cooler which cools the air down.

The air then enters the second compression stage where it again heats up due to compression. Before exiting the compressor, the compressed air passes through an After-cooler to cool it to a more usable level.

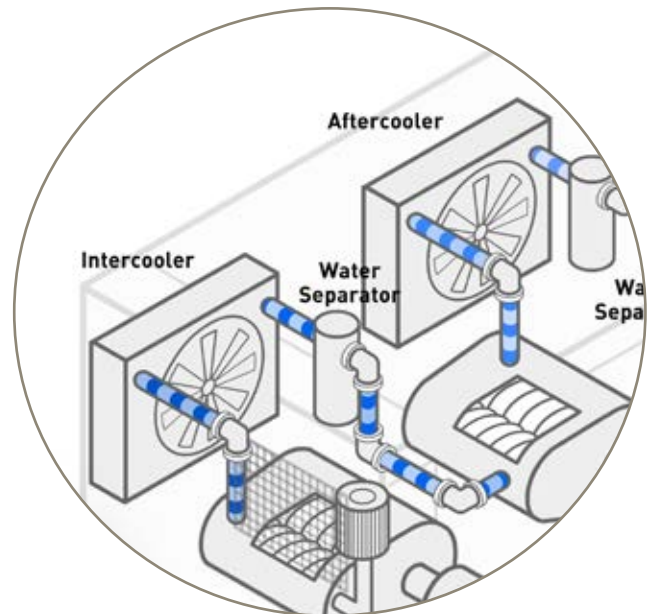

## Liquid & Aerosol Introduction

As the inter-cooler and after-cooler cool the compressed air, they reduce the air's ability to hold water and oil vapours. Cooling condenses the vapours into liquid water and liquid oil which is carried along in the air at high velocity. Rough internal surfaces of the piping, bends, elbows, fittings, etc. all disrupt the flow of condensed liquids. This disruption causes the condensed liquids to 'shear' or atomise, producing fine droplets or aerosols of water and oil.

## Liquid Reduction

Many air compressors are fitted with an integrated water separator at the outlet of the inter-cooler and at the outlet of the after-cooler to reduce liquids. Some compressor designs rely on an external water separator or use a wet air receiver for liquid reduction.

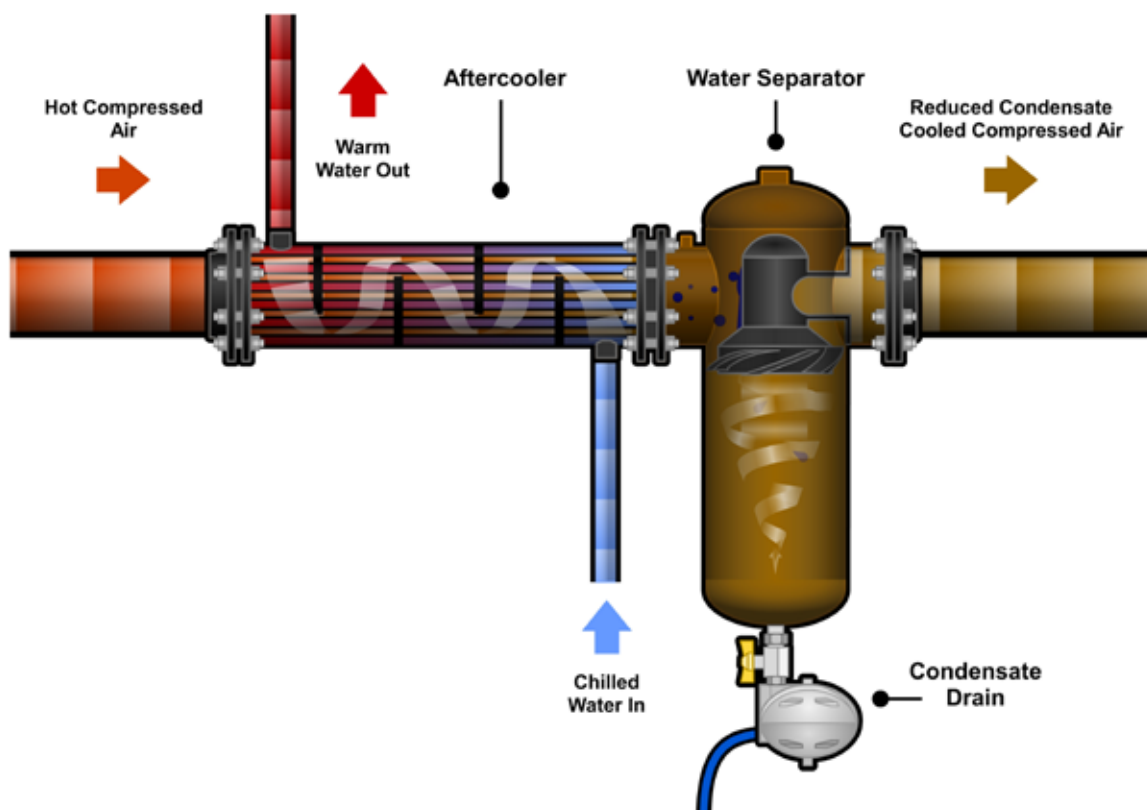

### Important Notes:

Water separators reduce liquids only, they are not effective for aerosol or vapour reduction and they will not remove 100% of the liquid present.

# Compressed Air Contaminants: Water Vapour, Condensed Liquid Water and Water Aerosols

As with oil, water will also be present in a compressed air system in 3 different phases (as a vapour, as an aerosol and as a liquid).



Water Vapour



Liquid Water

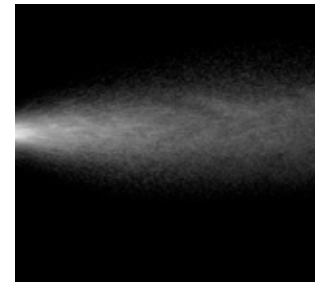

Water Aerosol

And will come from two sources:

Source 1 - the ambient air (water vapour)

Source 2 - the air compressor (liquid water and water aerosols / 100% saturated with water vapour)

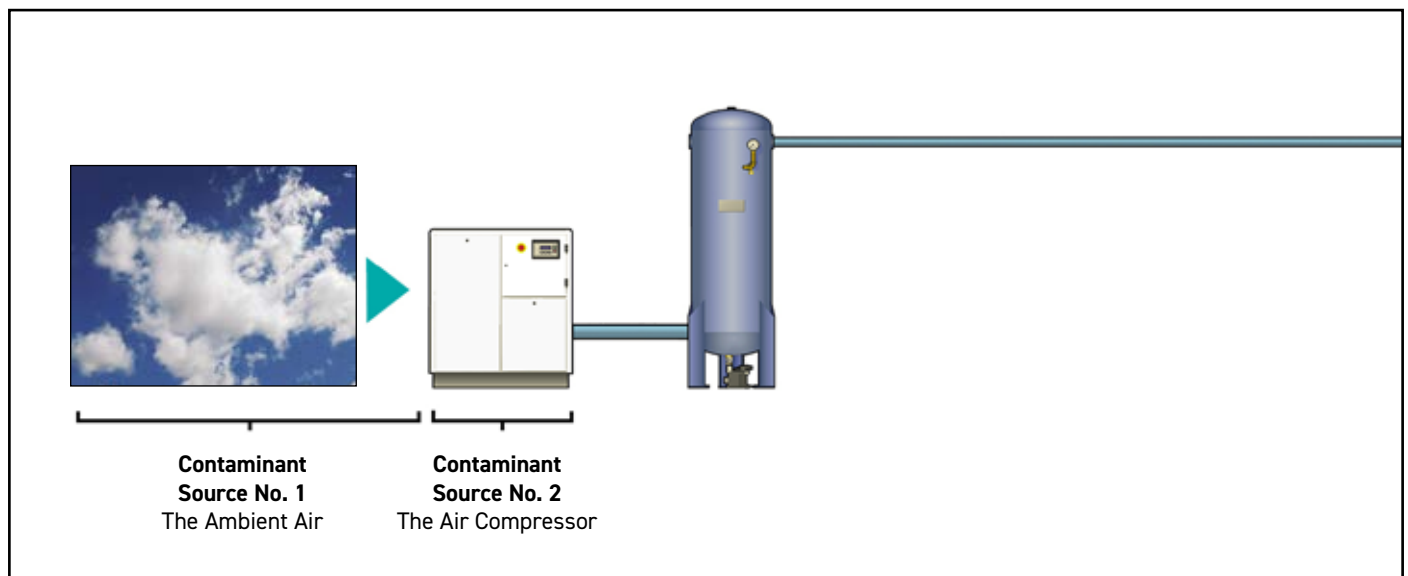

## Water Vapour in Ambient Air

Ambient air contains water vapour (water in a gaseous form). Air's ability to hold water vapour is dependent upon its temperature and pressure. As pressure increases, a lesser amount of water vapour can be held by the air, however as air temperature increases, a greater amount of water vapour can be held by the air.

**As a general rule, every 10°C increase in ambient air temperature doubles the amount of water vapour the air can hold.**

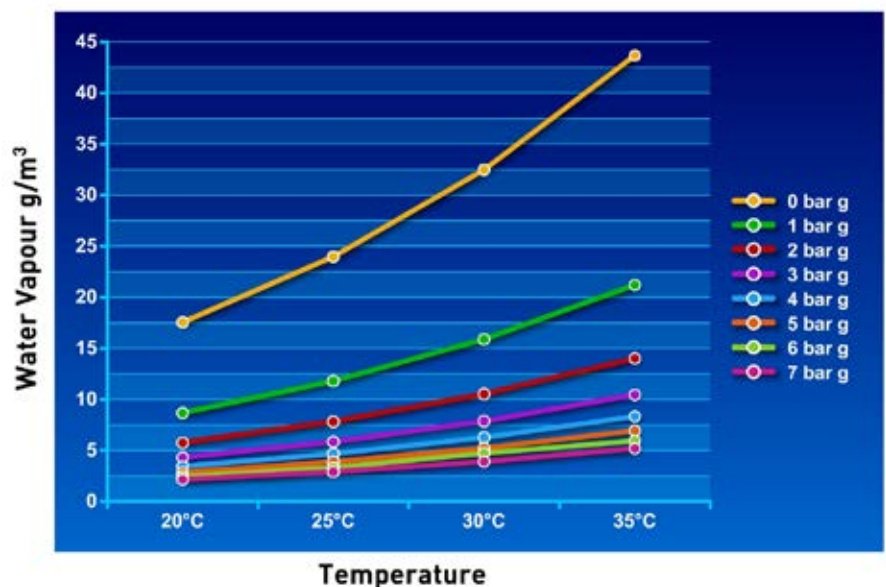

# Compressing the Air

As previously described, the air compressor draws in large volumes of ambient air. Each cubic metre of ambient air will be saturated with water vapour. The amount of saturation will be based upon atmospheric conditions at the geographic location of the installation and will typically vary hour by hour, day by day. The saturation of ambient air is referred to as Relative Humidity or RH and is expressed as a percentage. Typically the RH of the ambient air entering the compressor is below 100% (making it partially saturated).

In the example (right), the partially saturated ambient air is drawn into the compressor and compressed to a pressure of 7 bar g (8 bar A), a compression ratio of 8:1.

When air is compressed rapidly, the temperature increases (according to the laws of thermodynamics). Although air's ability to hold water vapour is reduced as it is compressed, the elevated temperature from compression significantly increases the water vapour holding capacity of the compressed air.

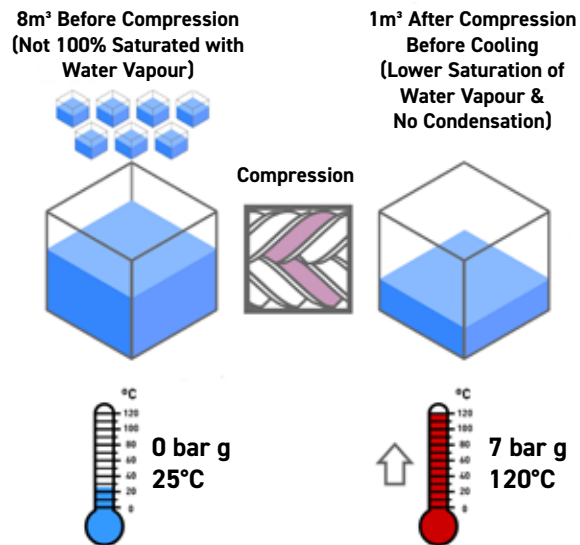

**Now, 1 cubic metre of compressed air can easily retain the moisture previously held by the 8 cubic metres of ambient air.**

After compression, compressed air is cooled to a more usable temperature by the after-cooler (typically 10-15°C above the ambient temperature).

Once cooled, the compressed air's ability to hold water vapour is significantly reduced (even below that of the ambient air), therefore the 1 cubic metre of compressed air is unable to retain all of the water vapour it previously held, resulting in condensation of water vapour into liquid water and compressed air that is 100% saturated with water vapour.

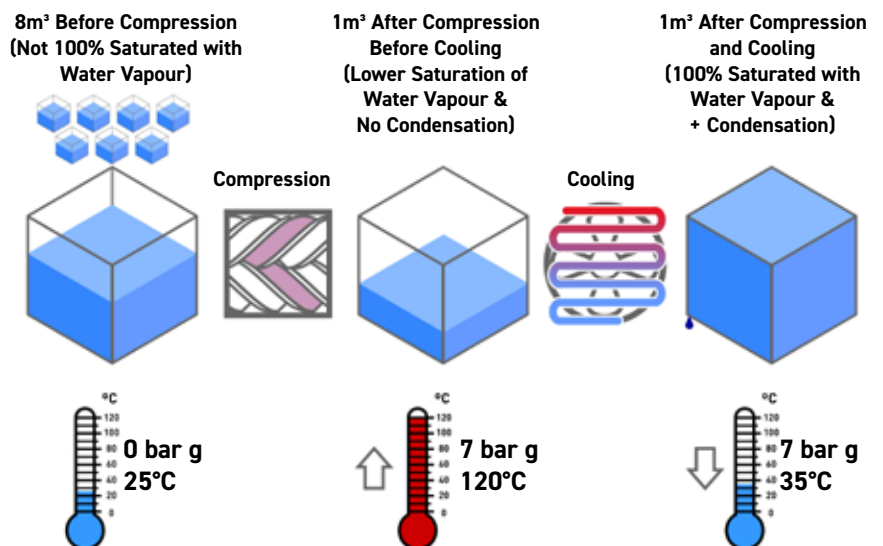

## Aerosol Introduction

As previously mentioned, the After-cooler causes condensation and introduces liquids (water & oil) into the compressed air which are carried along in the air at high velocity.

The rough internal surfaces of the piping, bends, elbows, fittings, etc. all disrupt the flow of condensed liquids. This disruption causes the condensed liquids to 'shear' or atomise, producing fine droplets or aerosols of water and oil.

## Liquid Reduction

Many air compressors are fitted with an integrated water separator at the outlet of the inter-cooler (on multi-stage compressors) and at the outlet of the after-cooler to reduce liquids. Some compressor designs rely on an external water separator or use a wet air receiver for liquid reduction.

### Important Note:

Water separators / wet air receivers will only reduce liquids and are not effective for aerosol or vapour reduction. Additionally, they will not remove 100% of the liquid present, therefore at the outlet of the after-cooler, the compressed air will contain:

- Liquid Water (from water vapour)
- Liquid Oil (from oil vapour)
- Water Aerosols
- Oil Aerosols
- Compressed air 100% saturated with water vapour

## The Water Problem Continues

As untreated compressed air exits the compressor / after-cooler and enters the storage and distribution system, it is 100% saturated with water vapour. The air receiver and system piping will continue to reduce the temperature of the compressed air (especially if the air receiver or any piping is outdoors). The temperature drop further reduces the air's ability to hold water vapour and causes the already 100% saturated compressed air to condense more water vapour and oil vapour into liquid water and liquid oil which in turn creates more aerosols as it travels around the compressed air piping system.

As compressed air expands during use, rapid cooling occurs, again reducing its ability to hold water vapour. So as the compressed air is used in valves, cylinders, tools & machinery, further liquid condensation is produced which on occasion can lead to freezing.

Saturated air, water aerosols and liquid water within the compressed air system cause:

- Increased microbiological contamination
- Corrosion to the storage & distribution system
- Damage to valves, cylinders, tools and production equipment
- Damage to products & packaging in direct contact with the air
- Reduction in production efficiency & Increased maintenance costs

Compressed air must be treated for water in all 3 phases (vapour / liquid / aerosol) for the system to run safely and efficiently.

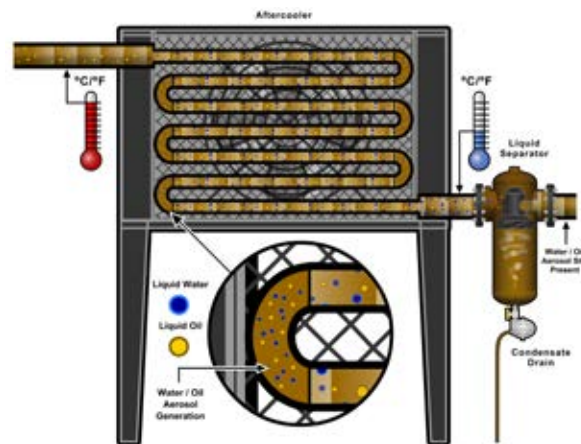

# Compressor Condensate

Oil, water and other harmful vapours drawn into the compressor intake cool and condense into liquids. Combined with compressor lubricants carried over from the compressor, these liquids traveling at high velocity through the compressor coolers and around piping systems mix the liquids with particulates from the piping to form acidic liquids and aerosols known as compressor condensate.

It was often thought that as compressor condensate was made up of oil, it would be useful for lubricating downstream tools, etc. but this is certainly not true. Due to its composition, compressor condensate causes damage to the compressed air storage and distribution system, production equipment, tools and any products or packaging it contacts.



## Oil-free Compressor Condensate

In addition to the benefits of direct cooling, the oil used in an oil lubricated compressor also provides additional benefits as it can also neutralise sulphur dioxide ( $\text{SO}_2$ ) drawn in through the compressor intake.

In an oil free compressor there is no oil to neutralise harmful vapours such as  $\text{SO}_2$ . As the inter-cooler and after-cooler in an oil-free compressor condenses water vapour into liquid water, the  $\text{SO}_2$  from the air reacts with the condensed water to form sulphurous acid (similar to acid rain). Measurements from compressed air systems show that the resulting condensate has a pH value between 3 and 6 attacking the downstream air receivers, piping and purification equipment more aggressively than condensate from lubricated compressors.

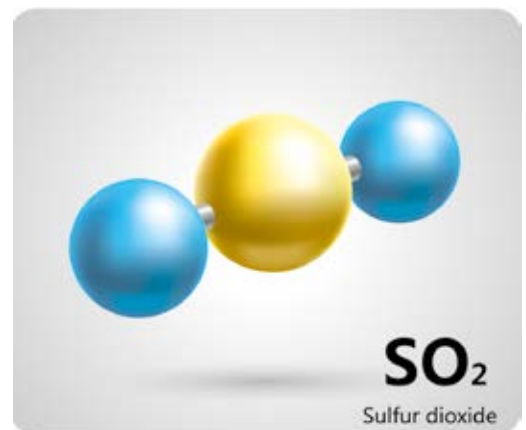

## Condensate Treatment

All types of compressed air condensate, including that condensate from an oil free compressor must be treated and discharged in a legal and responsible manner. Most countries have strict laws governing liquid discharges in order to protect water courses, wild life and sewerage treatment plants.

# Compressed Air Contaminants: Atmospheric Particulate

On average, each cubic meter of ambient air can typically contain between 140 and 150 million dirt particles.



80% of these particles are less than 2 microns in size and not visible to the human eye.

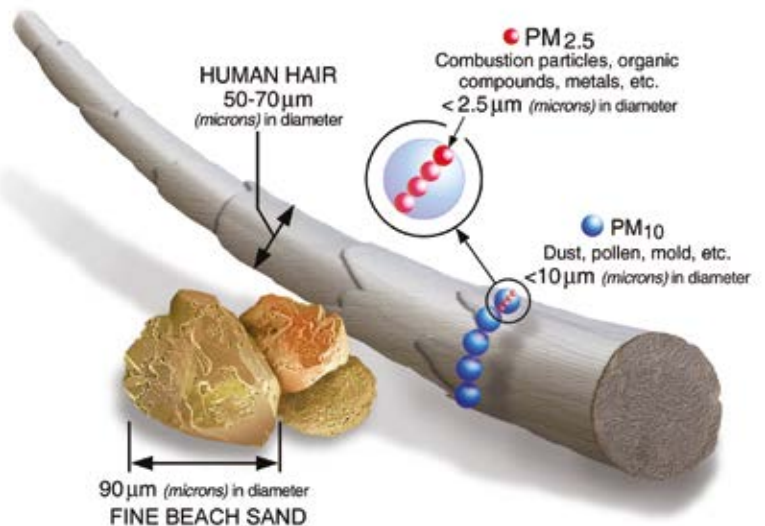

At this size, they are also too small to be captured by the compressor intake filter.

As air compressors require unrestricted access to large volumes of ambient air, placing a fine filter on the compressor intake has a detrimental effect to performance, reducing the volume of air delivered by the compressor at the outlet.

Therefore, most compressor intake filters only trap particles down as low as 25 microns. This means that most of the particulate present in the ambient air are too small to be captured by the intake filter and will travel unrestricted into the compressed air system.

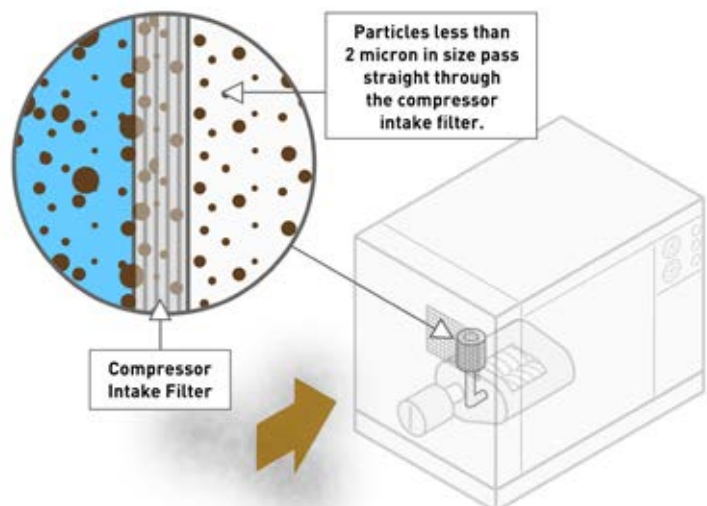

# Compressed Air Contaminants: Micro-organisms

Ambient air contains both viable and non-viable particles. A non-viable particle is a particle that does not contain a living micro-organism but acts as transportation for viable particles. A viable particle is a particle that contains one or more living micro-organisms.

There can be up to 100 million micro-organisms per cubic metre of ambient air. Particle analysers used to count particles in air typically use light scattering techniques and when measurements of ambient air are taken they are unable to determine the difference between solid particles and micro-organisms such as bacteria, viruses, fungi & spores.

Of the 140 million particles counted in a cubic meter of ambient air, anywhere up to 100 million of the particles may be micro-organisms.

## **Micro-organisms are typically between 0.2µm and 10µm in size:**

- Viruses 0.02µm - 0.2µm
- Bacteria 0.3 µm - 5µm
- Fungi (Yeasts) 3µm - 10µm

Unlike other contaminants, given the right environment, micro-organisms can grow rapidly. The warm moist air found in an untreated compressed air system provides the ideal environment for microbial growth.

It was often thought that the high temperatures reached by the air during compression would kill of the micro-organisms, however this is not the case as for example, many bacteria can form spores which can lie dormant for extended periods until the conditions once again become right for growth. The air receiver and distribution piping provide the ideal environments for their ever expanding growth and distribution.

Many critical applications require sterility or at least a degree of control of over the growth of micro-organisms. If contaminated compressed air can directly or indirectly contact products, packaging or production machinery, then contamination is likely.

## **This can cause enormous financial damage for a company as micro-organisms can:**

- Potentially harm the consumer
- Diminish product quality
- Render a product entirely unfit for use
- Lead to a product recall
- Cause legal action against a company and damage the brand

Micro-organisms don't just cause issues for critical applications or sterile processes. Compressed air is used widely in general industry.

Untreated compressed air exhausted from pneumatic tools, valves, cylinder or machinery will also contain micro-organisms. If this exhausted air is inhaled by employees working in the vicinity or using tools / machinery it can also lead to excessive work force illness.

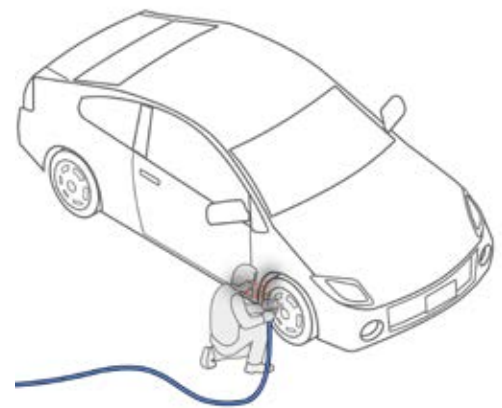

# Compressed Air Contaminants: Rust & Pipescale

If left untreated, warm, moist compressed air causes corrosion of air receivers and piping.

Air compressors & purification equipment are changed on a much more frequent basis than air receivers and piping.

Therefore, even with new compressors and purification equipment installed, many years of rust and pipescale build up will still be in the system.

Over time, this rust and pipescale slowly breaks away to cause damage or blockage in tools, valves, cylinders and production equipment.

If the compressed air is used directly in the manufacturing process, it can also contaminate final product or processes or packaging.



## Compressing Air - The Problem Increases

To many, the levels of contaminants in the ambient air may be considered 'negligible', however when we talk about compressed air contamination, we must also consider the effect that compressing the air has on the ambient contamination, the amount of air flowing into the compressed air system and the time the compressor is operating.

### The Concentrating Effects of Compression

When operating, the air compressor is constantly pulling in large volumes of ambient air.

As operating pressure and or flow rate increases, a larger volume of ambient air is required. The greater the volume of ambient air, the greater the amount of contamination.

For example: In simplistic terms, to generate 1 cubic meter of air at a pressure of 7 bar g (8 bar A) requires 8 cubic meters of ambient air.

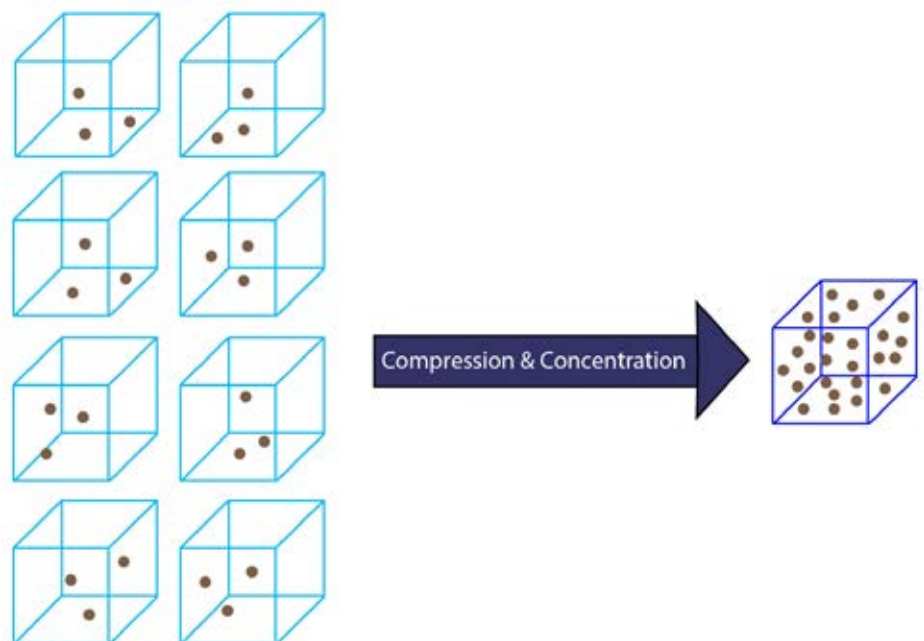



# Myth

When the stored compressed air is used, it is expanded back to ambient pressure and there are those that believe that when this expansion takes place, the levels of contamination return to the ambient levels and are therefore 'negligible'. This unfortunately isn't true.

**MYTH**

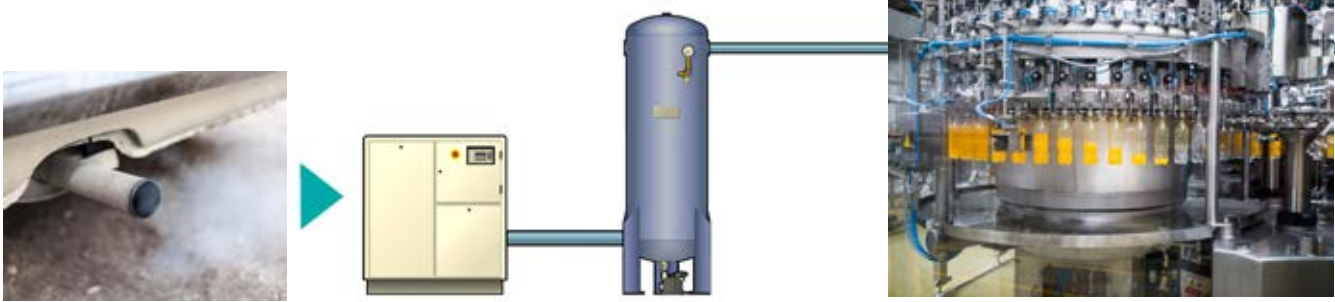

**Ambient air containing contamination enters the air compressor**

**Ambient air is compressed resulting in concentration of contaminants**

**Compressed air is expanded during use resulting in concentration returning to ambient levels**

# Fact

When the air is compressed, the heat of compression makes the compressed air too hot to use, so it must be cooled to a usable temperature. Inter-coolers and after-coolers are installed for the reduction of the compressed air temperature (either integrated into the compressor or fitted externally). As the air is cooled, condensation of the gaseous contaminants into liquids and their subsequent conversion into aerosols (very fine droplets) takes place in the coolers. Unfortunately, the liquid separators supplied with the coolers are unable to remove 100% of the liquids and are completely ineffective on aerosol and vapour reduction. Therefore, untreated compressed air is heavily contaminated by the time it exits the compressor after-cooler and reaches the point of use.

**FACT**

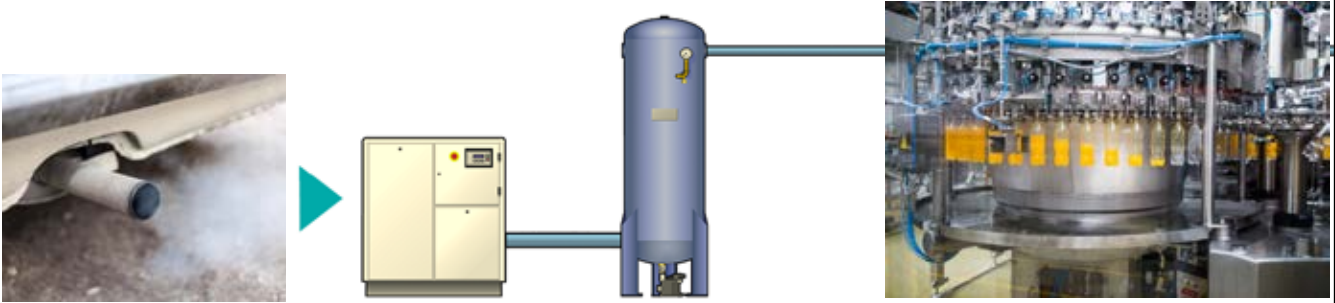

**Ambient air containing contamination enters the air compressor**

**Ambient air is compressed resulting in concentration of contaminants. Compressed air is also cooled, concentrated gaseous contaminants change phase and drop out as liquids and form aerosols**

**Compressed air is expanded during use, concentration is not the same as ambient levels - heavy contamination present**

# The Concentrating Effects of Compression Ambient / Compressed Air Contamination

Contamination	Before Compression	After Compression
	Per m <sup>3</sup>	Per m <sup>3</sup>
Water Vapour (Saturation)	50 – 90% RH (Partially Saturated)	100% RH (Fully Saturated)
Liquid Water	None Present	Present
Water Aerosols	None Present	Present
Oil Vapour (From Ambient Air)	0.05 mg/m <sup>3</sup> - 0.5 mg/m <sup>3</sup>	0.4 mg/m <sup>3</sup> - 4 mg/m <sup>3</sup>
Oil Aerosols from Condensed Oil Vapour (All Compressor Types)	None Present	Present
Oil Vapour (From Compressor)	None Present	Present
Compressor Oil (Liquid Oil & Oil Aerosol)	None Present	2-200 mg/m <sup>3</sup> carryover
Atmospheric Particulate	Up to 140 million/m <sup>3</sup>	Up to 896 million/m <sup>3</sup>
Micro-organisms	Up to 100 million/m <sup>3</sup>	Up to 800 million/m <sup>3</sup>
Rust	None Present	Present
Pipescale	None Present	Present

The table above is based upon a typical compressed air system operating at a pressure of 7 barg (8 bar A). As pressure changes, so does the concentration of contamination as can be seen in the examples below.

	Ambient	Pressure						
Pressure (bar g)	0	5	7	8	10	13	14	16
Concentration	1	6	8	9	11	14	15	17
Oil Vapour mg/m <sup>3</sup>	0.05	0.3	0.4	0.5	0.6	0.7	0.8	0.9
No of Particles per m <sup>3</sup> (million)	112	672	896	1,008	1,232	1,568	1,680	1,904
Micro-organisms per m <sup>3</sup> (million)	100	600	800	900	1,100	1,400	1,500	1,700

# Which contaminant causes the most problems?

It is often believed that oil introduced by the air compressor causes the most problems in a compressed air system. However, oil is not the major problem everyone thinks it is.

In reality, the most problematic contaminants are water and micro-organisms. The presence of one directly impacts the growth of the other.

## Water causes:

- The growth of micro-organisms
- The formation of rust and pinescale
- The production of oily, acidic compressor condensate



Oil is often perceived to be the most prolific contaminant as it can be seen emanating from open drain points and exhausting valves.

In the majority of instances, it is actually oily condensate (oil mixed with water) that is being observed.



## So how big is the water problem?

The table below provides an example as to how much water can enter a compressed air system per hour and per year.

This example is based upon a single compressor 75kW operating in typical Northern European conditions.

75kW Compressor - 825 m <sup>3</sup> /hr @ 7.5 bar g Pressure						
Ambient Temp (°C)	RH %	Discharge Temp (°C)	Water Vapour Entering Compressor (L/hr)	Liquid Water Removed at the After-cooler (L/hr)	Remaining Water Vapour Entering the Compressed Air System (L/hr)	Total Water Vapour Entering the Compressed Air System Per Year (L)
10°C	65	20°C	4.88	1.67	3.21	28,043
15°C	65	25°C	6.82	2.26	4.56	39,836
20°C	65	30°C	9.41	3.03	6.38	55,736
25°C	65	35°C	12.85	4.03	8.82	77,052
30°C	65	40°C	17.42	5.29	12.13	105,968

# Contaminant Reduction

To operate any compressed air system, safely and cost effectively, contamination must be reduced to acceptable limits. The importance of reducing contamination is increased when compressed air is used as part of a manufacturing process.

Poor compressed air quality and failure to control contamination can cause numerous problems for an organisation, many of which are not immediately associated with contaminated compressed air.

## Product

- Contaminated products
- Contaminated packaging
- Spoiled / damaged products

## Consumer

- Potentially unwell / seriously ill consumers  
(Food / Beverage / Pharmaceutical applications)

## Manufacturer

- Brand damage
- Potential Legal actions
- Financial loss
- Potential imprisonment

## Manufacturing Process

- Inefficient production processes
- Reduced production efficiency
- Increased manufacturing costs
- Failed quality audits

## Compressed Air System

- Growth, storage & distribution of microbiological contamination
- Corrosion within storage vessels and the distribution system
- Contaminated / damaged production equipment
- Blocked or frozen valves & cylinders
- Premature unplanned desiccant changes for adsorption dryers
- High operational and maintenance costs

## Contaminant control

Ensuring effective control of compressed air contamination, requires a number of purification technologies. To many compressed air users, the realisation that there are ten major contaminants in a compressed air system is somewhat of a surprise. It is often thought that only three contaminants are present (Dirt / Water / Oil), however as those contaminants can be found in many phases, they therefore require a specific purification technology for efficient reduction. The table below highlights filtration & drying technologies that comprise the purification system and the contaminants they reduce.

Purification Technologies	Contaminants									
	Atmospheric Particles	Rust	Pipescale	Micro-organisms	Liquid Water	Water Aerosol	Water Vapour	Liquid Oil	Oil Aerosol	Oil Vapour
Water Separator					●			●		
Coalescing Filters	●	●	●	●		●			●	
Adsorption Filter										●
Dryer							●			
Dry Particulate Filter	●	●	●	●						
Sterile Filters				●						

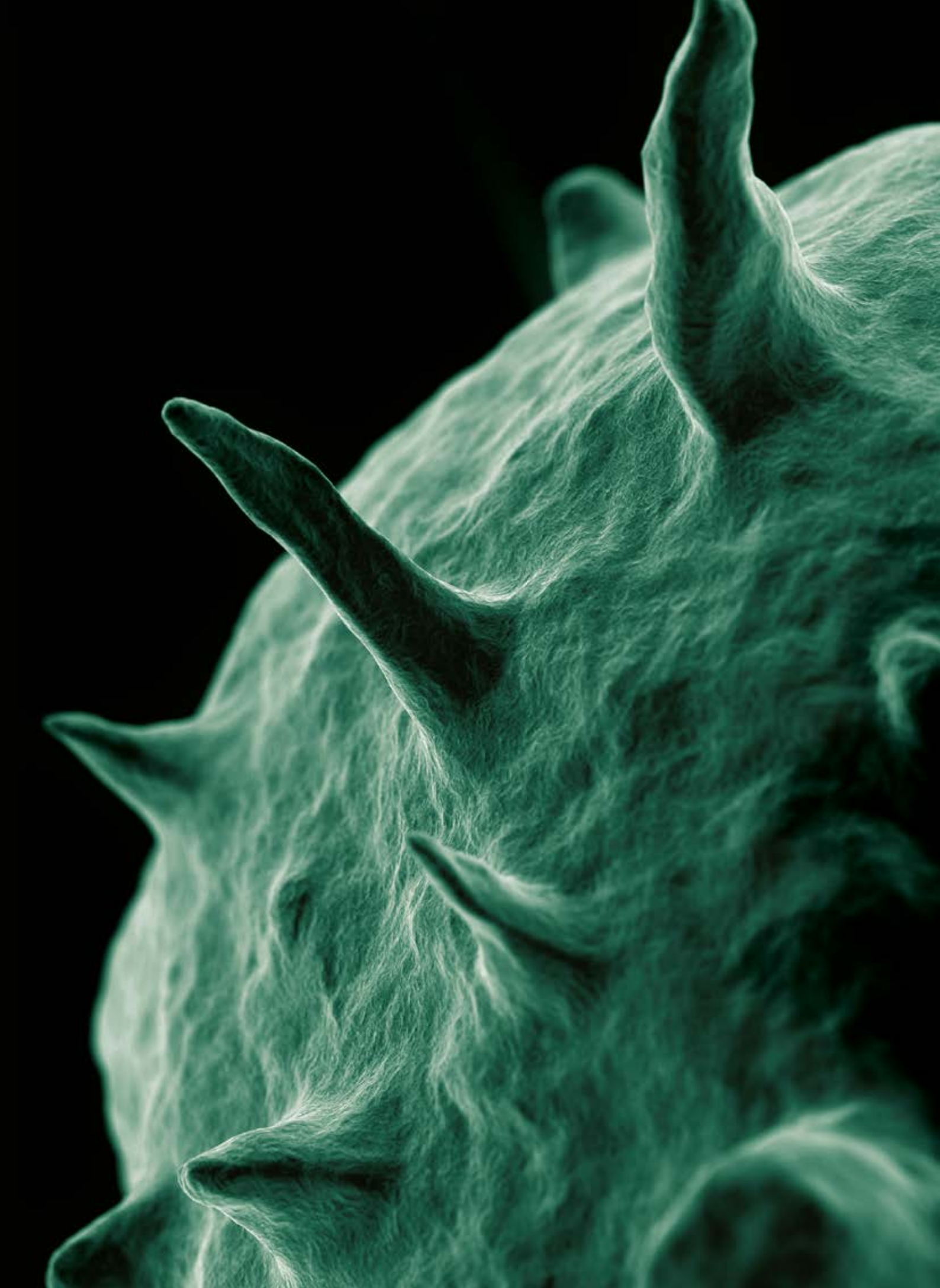

## Compressed Air Treatment

## Compressor Room

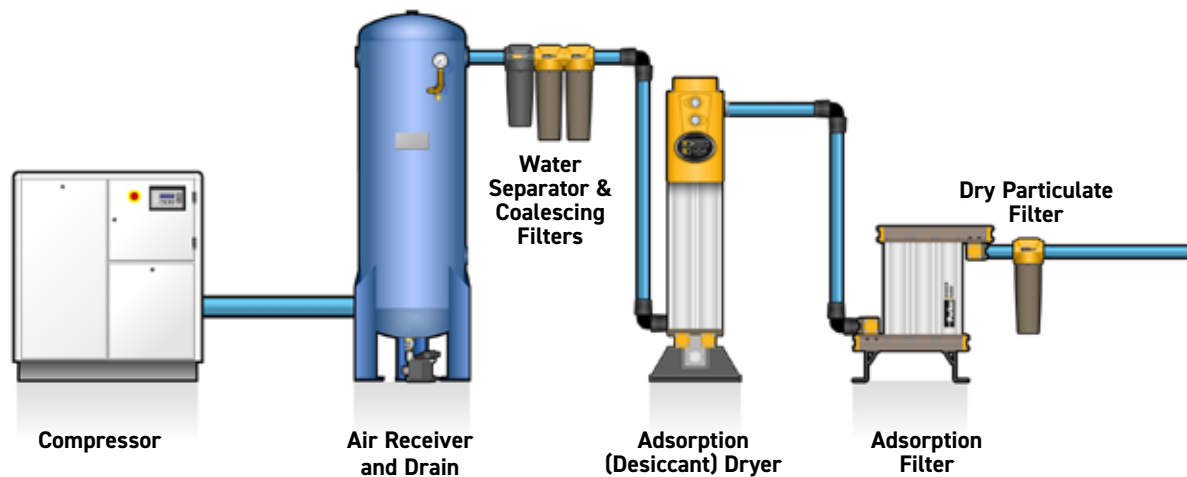

### Water separators

Although called water separators, they reduce the content of all liquids at the point of installation. Liquid in a compressed air system is usually a mixture of oil and water (even when using an oil free compressor).

Water separators are usually the first piece of purification equipment installed downstream of an after-cooler or wet air receiver and should be used to protect coalescing filters from liquid contamination. They will only reduce liquids and will have no effect on water or oil in an aerosol or vapour phase.

### Coalescing filters

When considering purification equipment, coalescing filters are vital for the cost effective operation of any compressed air system, regardless of the type of compressor installed.

A purification system will normally consist of two coalescing filters installed in series to treat water aerosols, oil aerosols, atmospheric particulate, micro-organisms, rust and pipscale.

### Compressed air dryers

Water vapour is water in a gaseous form and will pass through water separators and coalescing filters just as easy as the compressed air. Water vapour is reduced from compressed air using a dryer. The water vapour reduction efficiency of a dryer (its performance) is expressed as a Pressure Dewpoint or PDP.

- **Dewpoint refers to the temperature at which condensation will occur.**
- **Pressure Dewpoint or PDP refers to the dewpoint of air above atmospheric pressure.**
- **Dewpoint is expressed as a temperature (however this is not the temperature of the compressed air).**
- **Compressed air with a PDP of  $-20^{\circ}\text{C}$ , would need the temperature to drop below  $-20^{\circ}\text{C}$  for any water vapour to condense into a liquid.**
- **A pressure dewpoint of  $-40^{\circ}\text{C}$  is recommended for all food, beverage and pharmaceutical applications where the compressed air directly or indirectly contacts production equipment, ingredients, packaging or finished products as a pressure dewpoint lower than  $-26^{\circ}\text{C}$  will not only stop corrosion, it will also inhibit the growth of micro-organisms.**

### Adsorption dryer

Adsorption dryers reduce water vapour in compressed air by passing air over a regenerative desiccant material which strips the moisture from the air. This method of drying is extremely efficient. A typical pressure dewpoint specified for an adsorption dryer is  $-40^{\circ}\text{C}$  as it not only prevents corrosion, more importantly it also inhibits the growth of micro-organisms.

There are many types of adsorption dryer available and whilst they all use the same principle to remove moisture from compressed air, there are a

number of different methods used for the regeneration of the wet adsorbent material.

For food, beverage and pharmaceutical applications, a dryer that can deliver a constant outlet dewpoint (not dewpoint suppression) should always be selected. Additionally, care should be taken when selecting adsorption dryers as some regeneration methods used may have an impact on the contamination levels of the compressed air.

### Refrigeration dryers (not shown)

Refrigeration dryers work by cooling the compressed air and condensing the water vapour into a liquid for reduction by a water separator.

Refrigeration dryers are limited to positive pressure dewpoint to prevent freezing of the condensed liquid and are typically used for general purpose industrial applications with indoor piping.

They should not be used in any facility where piping is installed in ambient temperatures below the dryer dewpoint i.e. systems with external air receivers or piping or for applications requiring control over the growth of micro-organisms.

### Adsorption filter

To ensure 'technically oil free air', adsorption filters are employed. These utilise a large bed of activated carbon adsorbent for the effective reduction of oil vapour.

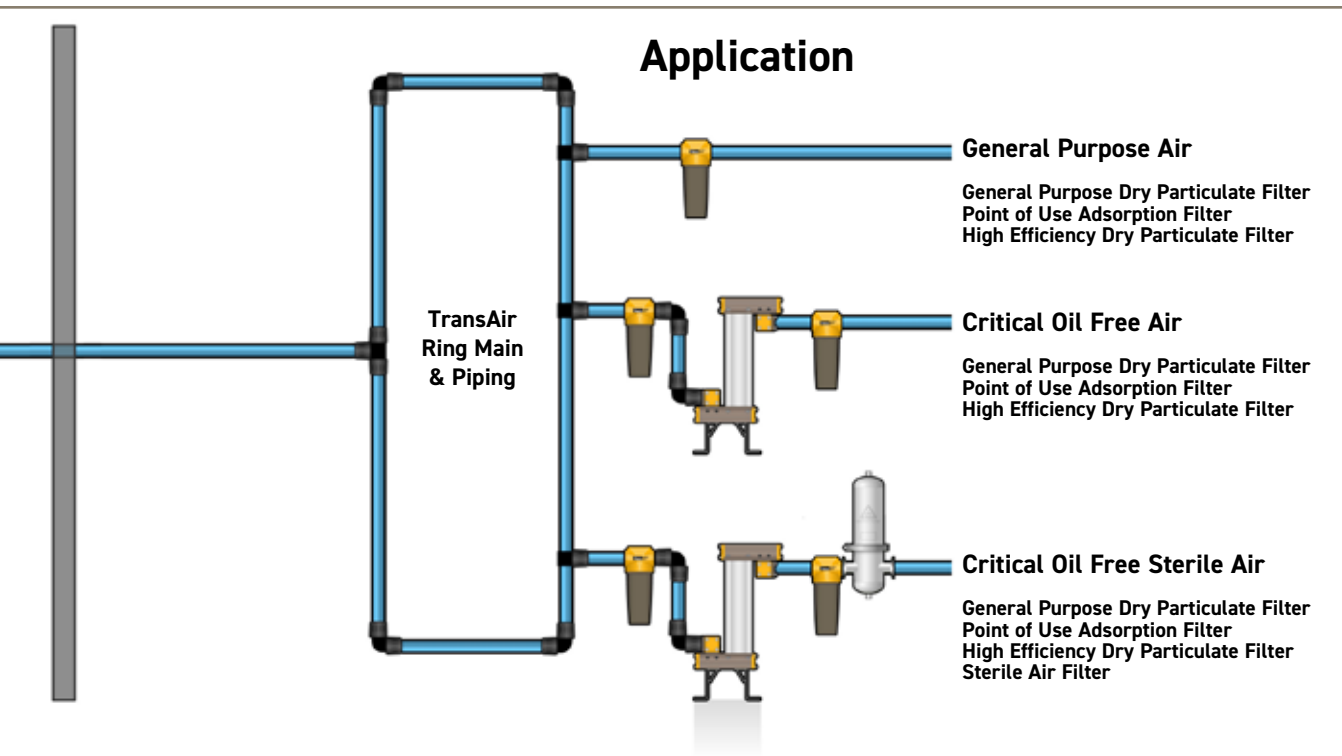

The combination of coalescing filters and adsorption filters will provide compressed air to the highest air quality classifications of ISO8573-1, the international standard for compressed air quality (for total oil).

#### Dry Particulate filters

Dry particulate filters provide identical particulate reduction performance to the equivalent grade coalescing filter.

Relying on mechanical filtration techniques, high efficiency dry particulate filters can provide particle reduction down to 0.01 micron with a removal efficiency of 99.9999%.

When coupled with a -40°C Pressure Dewpoint, to inhibit and control the growth of micro-organisms, they can provide significant reduction of microbiological contaminants.

#### Sterile filters

Absolute (100%) removal of solid particulates and micro-organisms is performed by a sieve retention or membrane filter. They are often referred to as sterile air filters as they also provide sterilised compressed air.

Filter housings are manufactured from stainless steel to allow for in-situ steam sterilisation of both the filter housing and element. It is important to note that the piping between the sterile filter and the application must also be cleaned and sterilised on a regular basis.

### Important Notes:

As adsorption or refrigeration dryers are only designed to reduce water vapour and not water in a liquid or aerosol form, they require the use of coalescing filters to work efficiently.

Suppliers of oil-free compressors will often state that one of the coalescing filters is a particulate filter and the other is an oil removal filter, therefore, in oil-free compressor installations, there is no need for the oil removal filter. This is not correct.

In reality, both filters remove exactly the same contaminants. The first filter is a general purpose filter which protects the second, high efficiency filter from heavy contamination.

Omitting one of the filters in the belief that it is an oil removal filter will result in poor air quality due to contaminant bypass (carryover), high operational costs due to the pressure loss across the filter and more frequent filter element changes. Most importantly, omitting one of the filters will also invalidate performance guarantees.

The dual coalescing filter installation ensures a continuous supply of high quality compressed air with the additional benefits of lower operational costs and minimal maintenance compared to a single high efficiency filter.

Refrigeration dryers are not recommended for food and beverage applications where compressed air comes into direct contact (or indirect contact) with ingredients, production equipment, finished products or packaging as the dewpoints provided are unable to inhibit microbiological growth.

Refrigeration dryers are commonly available with quoted dewpoints of +3°C, +7°C or +10°C, however care must be taken when selecting this type of dryer as unlike adsorption dryers, the dewpoint quoted is not always provided constantly. Integrated dewpoint meters are typically just temperature gauges and do not indicate a true pressure dewpoint, which is often in the range of 8°C to 15°C (manufacturer dependent).

# Parker Worldwide

## Europe, Middle East, Africa

**AE – United Arab Emirates,**  
Dubai

Tel: +971 4 8127100  
parker.me@parker.com

**AT – Austria,** St. Florian

Tel: +43 (0)7224 66201  
parker.austria@parker.com

**AZ – Azerbaijan,** Baku

Tel: +994 50 2233 458  
parker.azerbaijan@parker.com

**BE/NL/LU – Benelux,**

Hendrik Ido Ambacht  
Tel: +31 (0)541 585 000  
parker.nl@parker.com

**BG – Bulgaria,** Sofia

Tel: +359 2 980 1344  
parker.bulgaria@parker.com

**BY – Belarus,** Minsk

Tel: +48 (0)22 573 24 00  
parker.poland@parker.com

**CH – Switzerland,** Etoy

Tel: +41 (0)21 821 87 00  
parker.switzerland@parker.com

**CZ – Czech Republic,** Klecany

Tel: +420 284 083 111  
parker.czechrepublic@parker.com

**DE – Germany,** Kaarst

Tel: +49 (0)2131 4016 0  
parker.germany@parker.com

**DK – Denmark,** Ballerup

Tel: +45 43 56 04 00  
parker.denmark@parker.com

**ES – Spain,** Madrid

Tel: +34 902 330 001  
parker.spain@parker.com

**FI – Finland,** Vantaa

Tel: +358 (0)20 753 2500  
parker.finland@parker.com

**FR – France,** Contamine s/Arve

Tel: +33 (0)4 50 25 80 25  
parker.france@parker.com

**GR – Greece,** Piraeus

Tel: +30 210 933 6450  
parker.greece@parker.com

**HU – Hungary,** Budaörs

Tel: +36 23 885 470  
parker.hungary@parker.com

**IE – Ireland,** Dublin

Tel: +353 (0)1 466 6370  
parker.ireland@parker.com

**IL – Israel**

Tel: +39 02 45 19 21  
parker.israel@parker.com

**IT – Italy,** Corsico (MI)

Tel: +39 02 45 19 21  
parker.italy@parker.com

**KZ – Kazakhstan,** Almaty

Tel: +7 7273 561 000  
parker.easteurope@parker.com

**NO – Norway,** Asker

Tel: +47 66 75 34 00  
parker.norway@parker.com

**PL – Poland,** Warsaw

Tel: +48 (0)22 573 24 00  
parker.poland@parker.com

**PT – Portugal**

Tel: +351 22 999 7360  
parker.portugal@parker.com

**RO – Romania,** Bucharest

Tel: +40 21 252 1382  
parker.romania@parker.com

**RU – Russia,** Moscow

Tel: +7 495 645-2156  
parker.russia@parker.com

**SE – Sweden,** Spånga

Tel: +46 (0)8 59 79 50 00  
parker.sweden@parker.com

**SK – Slovakia,** Banská Bystrica

Tel: +421 484 162 252  
parker.slovakia@parker.com

**SL – Slovenia,** Novo Mesto

Tel: +386 7 337 6650  
parker.slovenia@parker.com

**TR – Turkey,** Istanbul

Tel: +90 216 4997081  
parker.turkey@parker.com

**UA – Ukraine,** Kiev

Tel: +48 (0)22 573 24 00  
parker.poland@parker.com

**UK – United Kingdom,** Warwick

Tel: +44 (0)1926 317 878  
parker.uk@parker.com

**ZA – South Africa,** Kempton Park

Tel: +27 (0)11 961 0700  
parker.southafrica@parker.com

## North America

**CA – Canada,** Milton, Ontario

Tel: +1 905 693 3000

**US – USA,** Cleveland

Tel: +1 216 896 3000

## Asia Pacific

**AU – Australia,** Castle Hill

Tel: +61 (0)2-9634 7777

**CN – China,** Shanghai

Tel: +86 21 2899 5000

**HK – Hong Kong**

Tel: +852 2428 8008

**IN – India,** Mumbai

Tel: +91 22 6513 7081-85

**JP – Japan,** Tokyo

Tel: +81 (0)3 6408 3901

**KR – South Korea,** Seoul

Tel: +82 2 559 0400

**MY – Malaysia,** Shah Alam

Tel: +60 3 7849 0800

**NZ – New Zealand,** Mt Wellington

Tel: +64 9 574 1744

**SG – Singapore**

Tel: +65 6887 6300

**TH – Thailand,** Bangkok

Tel: +662 186 7000

**TW – Taiwan,** Taipei

Tel: +886 2 2298 8987

## South America

**AR – Argentina,** Buenos Aires

Tel: +54 3327 44 4129

**BR – Brazil,** Sao Jose dos Campos

Tel: +55 800 727 5374

**CL – Chile,** Santiago

Tel: +56 2 623 1216

**MX – Mexico,** Toluca

Tel: +52 72 2275 4200



### EMEA Product Information Centre

Free phone: 00 800 27 27 5374

(From AT, BE, CH, CZ, DE, DK, EE, ES, FI, FR, IE, IL, IS, IT, LU, MT, NL, NO, PL, PT, RU, SE, SK, UK, ZA)

### US Product Information Centre

Toll-free number: 1-800-27 27 537

[www.parker.com/gsf](http://www.parker.com/gsf)